

Project:

Type:

Prepared By:

Date:



UPC: 019813750088

Features and Benefits

- Energy efficient replacement for incandescent and halogen reflector lamps
- Constructed from durable plastic which lowers risk of breakage
- Rated for use in enclosed and open fixtures in dry or damp locations
- Frosted lens produces smooth diffuse light
- Longer lifespan compared to legacy equivalents minimizes replacement and maintenance costs
- ENERGY STAR Compliant
- Dimmable with common dimmer types (see Dimmer Compatibility List)

Technical Specifications

Performance

Product Type:
Reflector

Input Wattage:
10W

Lumens:
750lm

Efficacy:
75lm/W

L70 Lifespan:
25,000-Hour LED lifespan based on IES LM-70 results

Wattage Equivalency:
65W

LED Characteristics

Color Accuracy (CRI):
90 CRI

Color Temperature:
4000K

Beam Angle:
120°

Electrical
Power Factor:
>0.9

Dimmable:
Yes, down to 10%

Input Voltage:
120V

Operating Frequency:
60 Hz

Operating Temperature:
-20°C to 40°C

Construction

Bulb Shape:
BR30

Enclosure Material:
Plastic

Housing Finish:
White

Lens Finish:
Frosted

Installation

Base Type:
E26 Edison

Other

Technology EQ:
Incandescent

Warranty:

RAB warrants that our LED products will be free from defects in materials and workmanship for a period of four (4) years from the date of delivery to the end user, including coverage of light output, color stability, driver performance and fixture finish. RAB's warranty is subject to all terms and conditions found at rablighting.com/warranty.

Compliance

UL Listed:
Yes

Technical Specifications (continued)

Environment:

Damp / Enclosed

T20 Compliant:

Yes, Title 20 Tier 2

T24 JA8 Compliant:

Complies with Title 24 Appendix JA8

Rohs:

Mercury and UV free. RoHS-compliant components.

FCC:

Complies with Part 15B of the FCC Rules

\ _____

Case and Pallet Dimensions

	QTY	LENGTH (in)	WIDTH (in)	HEIGHT (in)
CASE	6	12	8	7
PALLET	840	47.9	40	39

Dimension

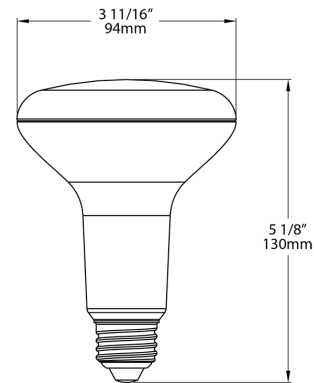

Light Distribution

