

CRLC SERIES

COMMERCIAL INDOOR LIGHTING

WESTGATE
THE FUTURE IS HERE...AND IT'S QUITE BRIGHT!

CRLC6-20W-MCTP-S-D

CRLC6-20W-MCTP-S-D-WH

6" LED COMMERCIAL SQUARE & OPEN RECESSED LIGHT



MCTP

Selection:



Ideal for hotel, offices, retail outlets, restaurant, parking garages, conference room, education facilities and more.

Customer Name: _____

Project Name: _____

Note: _____

Type: _____

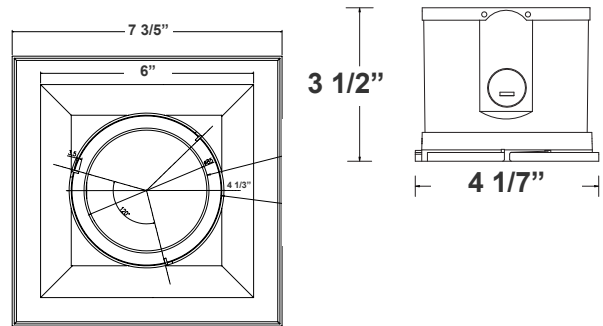
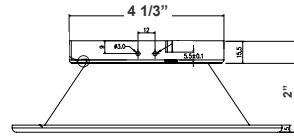

6"(H) X 4 1/7" (W)

Features

- 6" Haze & White Finish TRIM
- MCTP: Multi Color Temperature & Multi Power/Wattage (Selectable)
- Mounting Options: Recessed
- 5-Year Warranty
- Lifespan: 50,000 hrs.

Technical Specifications

Electrical:

- Voltage: 120-277VAC 50/60Hz
- Wattage: 10W/15W/20W
- Power Factor: >0.90
- Efficacy: 86 LPW

Mechanical:

- 6" Haze & White Finish TRIM
- Mounting Options: Recessed
- Temperature Rating: Designed To Operate In Temperatures 113°F
- No IC-Rated
- Housing Not Required. Two Spring Clips To Hold The Fixture In Place
- Suitable for Damp Locations
- 5-Year Warranty

Lighting:

- MCTP: Multi Color Temperature & Multi Power/Wattage (Selectable)
- Dimming: 0~10V Dimmable
- Total Lumens: 1720LM
- Color Temperature: 3000K/3500K/4000K
- Color Rendering index: >80
- Lifespan: 50,000 hrs.

Applications:

- Ideal for hotel, offices, retail outlets, restaurant, parking garages, conference room, education facilities and more.

Other Models:

- 20W | 1720LM | CRLC6-20W-MCTP-S-D
- 20W | 1720LM | CRLC6-20W-MCTP-S-D-WH



Phone: (877) 805-2252 | Fax: (877) 805-2252
www.westgatemfg.com



WG-Z7-2D-2Z

Photometrics: CRLC6-20W-MCTP-S-D

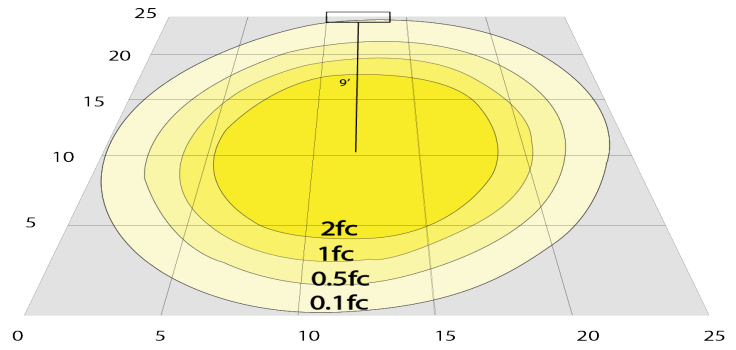
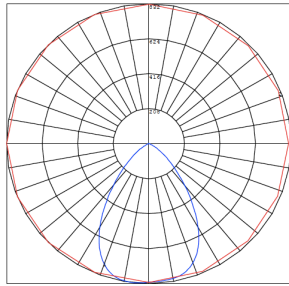
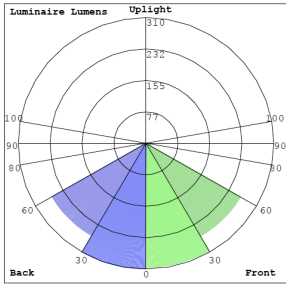

BUG Rating: B1-U1-G0

20W 5000K, Area 25" x 25" Mounting Height: 9'

Other Views:



Performance Table: CRLC6-20W-MCTP-S-D

MODEL NO.	Wattage	Voltage	Lumens	Color Temp.	BUG Rating	LPW
CRLC6-20W-MCTP-S-D	10W	120-277V	860LM	3000K	B1-U1-G0	86
CRLC6-20W-MCTP-S-D-WH	15W		1290LM	3500K		
	20W		1720LM	4000K		

Sample Ordering

Model Watt Shape Dimming Housing

CRLC6 - 20W - MCTP - S - D -

Blank
WH = WHITE

Accessory:

Blank = No Option For Accessories
SSL6-RI = 6" SQUARE ROUGH-IN PLATE, 26" LONG

Factory-Installed Option:

Blank = No Option For Accessories
OPT-EM-HB1EXT = EXTERNAL EMERGENCY BACK UP BATTERY

Accessory:

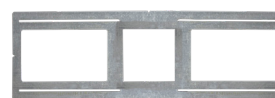

SSL6-RI
6" SQUARE ROUGH-IN
PLATE, 26" LONG

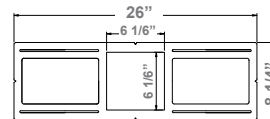

SSL6-RI
26"(W) x 8 1/4"(H)

Factory-Installed Option:



OPT-EM-HB1EXT
EXTERNAL EMERGENCY
BACK UP BATTERY

Example:

- CRLC6-20W-MCTP-S-D (FOR 20W CRLC6 MCTP 120-277V)
- CRLC6-20W-MCTP-S-D OPT-EM-HB1EXT (FOR 20W CRLC6 MCTP 120-277V) (EXTERNAL EMERGENCY BACK UP BATTERY)

