



Color: White w/brushed nickel ring

Weight: 3.9 lbs

Project:	Type:
Prepared By:	Date:

Driver Info		LED Info	
Type	Constant Current	Watts	20W
120V	0.19A	Color Temp	2700/3000/3500/4000/5000K
208V	0.11A	Color Accuracy	90 CRI
240V	0.09A	L70 Lifespan	50,000 Hours
277V	0.08A	Lumens	1,400 lm
Input Watts	20W	Efficacy	70

Technical Specifications

Performance

Product Type:

Flush Mount

Description:

5-CCT selectable, back-lit LED retrofit fixture with decorative ring. Installs on standard junction boxes. Dimmable models available for 0-10V or TRIAC dimming systems with optional microwave sensor and/or integrated emergency battery backup.

Wattage Equivalency:

125W Incandescent

Input Wattage:

20W

Nominal Lumens:

1,400lm

Efficacy:

70lm/W

Measured Lumens:

1435lm @ 2700K; 1593lm @ 3000K; 1678lm @ 3500K; 1689lm @ 4000K; 1604lm @ 5000K

Lifespan:

50,000-Hour LED lifespan based on IES LM-70 results

Electrical

Driver:

Constant Current, Class 2

THD:

≤20%

Power Factor:

≥0.9

Dimmable:

Yes, dimmable down to 10% on compatible 0-10V dimming systems. See Dimmer Compatibility List. Requires separate 0-10V DC dimming circuit.

Input Voltage:

120-277V

Operating Frequency:

50/60Hz

Input Current @ 120V (mA):

185mA

Input Current @ 208V (mA):

107mA

Input Current @ 240V (mA):

90mA

Input Current @ 277V (mA):

78mA

Operating Temperature:

-4°F to 104°F (-20°C to 40°C)

Sensor Settings

Sensor Connection Type:

Integrated, behind the lens

Max Mounting Height:

9 ft

Detection Range:

20 ft diameter at 9 ft mounting height

Sensor Technology:

Microwave (MVS)

Default Setting:

30 second timeout

Adjustable Sensor Settings?:

Yes, using MSR1 remote.

Sensing Type:

Occupancy, Vacancy

Occupied Actions:

On at 100% dim level

Technical Specifications (continued)**Vacant Actions:**

Off

Occupancy Timeout:

30 seconds

LED Characteristics**Beam Angle:**

130°

Color Temperature:Field adjustable via dip switch
2700/3000/3500/4000/5000K**Color Accuracy (CRI):**

90 CRI

R9 Value:

High color performance with R9 greater than 50

Color Consistency:<4-step (2700K & 5000K); <7-step
(3000K/3500K/4000K) MacAdam Ellipse binning to
achieve consistent fixture-to-fixture color**Color Stability:**LED color temperature is warrantied to shift no more
than 200K in color temperature over a 5-year period**Color Uniformity:**RAB's range of Correlated Color Temperature follows
the guidelines of the American National Standard for
Specifications for the Chromaticity of Solid State
Lighting (SSL) Products, ANSI C78.377-2017.**Installation****Mounting:**

Surface mount

Construction**Size:**

14"

Shape:

Round

Finish:

White w/brushed nickel ring

Trim Style:

Smooth

Lens Finish:

Frosted

Lens:Polycarbonate light diffuser distributes light evenly
and smoothly for general lighting applications**Compliance****Listings:**

UL Listed

Environment:Suitable for use indoors and outdoors in dry, damp,
or wet environments.**IC Rated:**

No

Air Tight:

No

Energy Star Approved:

This product is ENERGY STAR® Certified.

DLC Listed:

No

Certification Model Number:

DLS0106(CRVFAD-14R-20-9CCT-UNV-BN/MVS)

California Title 20 Compliant:Can be used to conform with the requirements of
California Title 20**California Title 24 JA8 Compliant:**Can be used to conform with the requirements of
California Title 24 Part 6**California Energy Commission (CEC) Status:**

Lawful for Sales in California

NEC Compliant:Suitable for use in closets. Compliant with NEC Sec.
410.16 (A)(1) and 410.16 (C1).**IESNA LM-79 & LM-80 Testing:**RAB LED luminaires and LED components have been
tested by an independent laboratory in accordance
with IESNA LM-79 and LM-80.**RoHS:**

Mercury and UV free. RoHS-compliant components.

FCC:

Complies with Part 15 of the FCC Rules

Trade Agreements Act Compliant:This product is a product of Cambodia and a
"designated country" end product that complies
with the Trade Agreements Act**Other****Compatible Accessories:**CRVFA-CONVERTIBLE-KIT
Pendant mount kit for CRVFA**Warranty:**RAB warrants that our LED products will be free from
defects in materials and workmanship for a period of
five (5) years from the date of delivery to the end
user, including coverage of light output, color
stability, driver performance and fixture finish. RAB's
warranty is subject to all terms and conditions found
at rablighting.com/warranty.

Dimensions

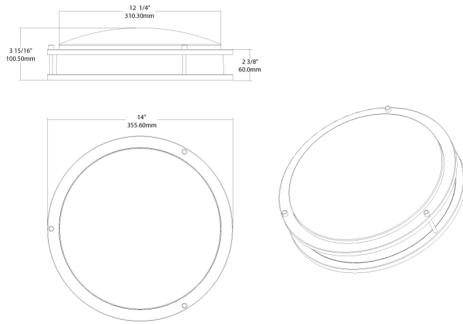

Features

- Surface mount to ceiling or wall
- Field-adjustable "set and forget" color temperature
- Decorative twin-ring design makes fixture ideal for residential applications
- Ideal for hospitality and multi-family residential applications
- Suitable for wet and damp locations

Coverage Pattern

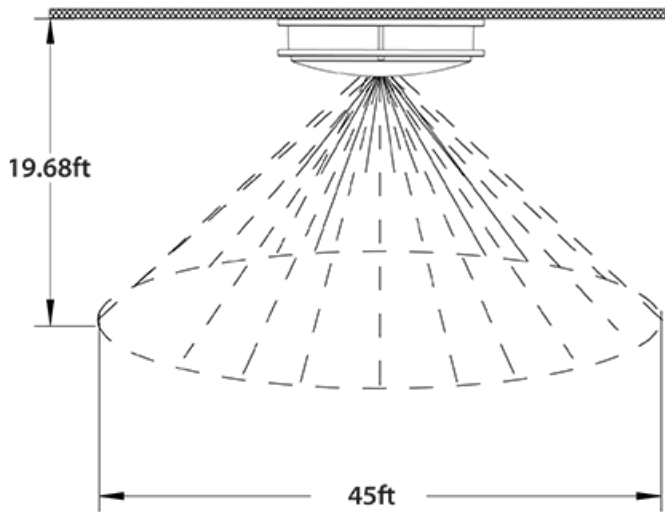

Ceiling Mount

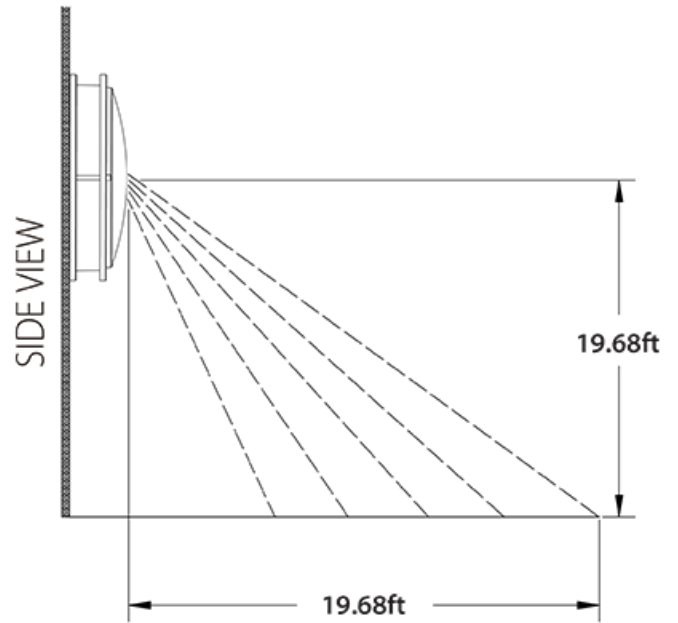

Wall Mount

Ordering Matrix

Family	Type	Size	Wattage	CRI/Color Temp	Driver	Finish	Sensor	Battery Backup
CRVFA	D	14	R	20	9CCT	UNV	BN	/MVS
	D = Decorative	11 = 11" 19 = 19" 18 = 18" 14 = 14" 12 = 12" R = Round	16 = 16W 20 = 20W 32 = 32W	9CCT = 90 CRI, 2700/3000/3500/4000/5000K CCT Adjustable	UNV = 120-277V, 0-10V Dimming UNVT = 120-277V, TRIAC/ELV	W = White BN = Brushed Nickel	Blank = No Option /MVS = Microwave Occupancy Sensor	Blank = No Option /EM = Emergency Battery Backup /EMBB = Emergency Battery Backup