



Project:	Type:
Prepared By:	Date:

Driver Info		LED Info	
Type	Constant Current	Watts	7W
120V	0.06A	Color Temp	2700/3000/3500/4000/5000K
208V	N/A	Color Accuracy	90 CRI
240V	N/A	L70 Lifespan	50,000 Hours
277V	N/A	Lumens	597-663 lm
Input Watts	6.5-6.7W	Efficacy	91.7-99.9 lm/W

Technical Specifications

Performance

Product Type:

Surface Mount

Description :

Contractor bulk pac, ultra-economy, CCT-adjustable surface mount disk lights

Wattage Equivalency:

60W Incandescent

Input Wattage:

7W

Lumens:

600lm

Efficacy:

86lm/W

L70 Lifespan:

50,000-Hour LED lifespan based on IES LM-70 results

Electrical

Driver:

Constant Current, 120V, 60 Hz; @ 120V: 60mA

Power Factor:

≥0.9

Dimmable:

Yes, dimmable down to 10% on compatible TRIAC/ELV dimming systems. See Dimmer Compatibility List.

Input Voltage:

120V

Operating Frequency:

60 Hz

Operating Temperature:

-4°F to 104°F (-20°C to 40°C)

Flicker:

<30%

LED Characteristics

Beam Angle:

90°

Color Temperature:

Field adjustable via dip switch
2700/3000/3500/4000/5000K

Color Accuracy (CRI):

90 CRI

Natural Spectrum:

No

R9 Value:

High color performance with R9 greater than 50

Color Consistency:

<4-step MacAdam Ellipse binning to achieve consistent fixture-to-fixture color

Installation

Mounting:

Surface Mount

Construction

Size:

4"

Shape:

Round

Finish:

White

Enclosure Material:

Plastic

Trim Style:

Smooth

Lens Finish:

Frosted

Technical Specifications (continued)**Lens:**

Twist-lock lens makes it easy to remove and attach during installation with UV resistant polycarbonate diffuser

\

Compliance**Listings:**

UL Listed

Environment:

Suitable for use indoors and outdoors in dry, damp, or wet environments.

IC Rated:

No

Air Tight:

No

Energy Star Approved:

This product is ENERGY STAR® Certified.

Certification Model Number:

DLS0190(DISK17-4/BP)

California Title 20 Compliant:

No

California Title 24 JA8 Compliant:

Can be used to conform with the requirements of California Title 24 Part 6

California Energy Commission (CEC) Status:

Lawful for Sales in California

NEC Compliant:

Suitable for use in closets. Compliant with NEC Sec. 410.16 (A)(1) and 410.16 (C1).

IESNA LM-79 & LM-80 Testing:

RAB LED luminaires and LED components have been tested by an independent laboratory in accordance with IESNA LM-79 and LM-80.

RoHS:

Mercury and UV free. RoHS-compliant components.

FCC:

Complies with Part 15 of the FCC Rules

Trade Agreements Act Compliant:

This product is a product of Cambodia and a "designated country" end product that complies with the Trade Agreements Act

Other**Compatible Products:**

DISK34-TRIM-4-BLK
4" Color trim for DISK round black

DISK34-TRIM-4-BN
4" Color trim for DISK round brushed nickel

DISK34-TRIM-4-BRZ
4" Color trim for DISK round bronze

5-Year Limited Warranty:

The RAB 5-year, limited warranty covers light output, driver performance and paint finish. RAB's warranty is subject to all terms and conditions found at rablighting.com/warranty.

Dimensions

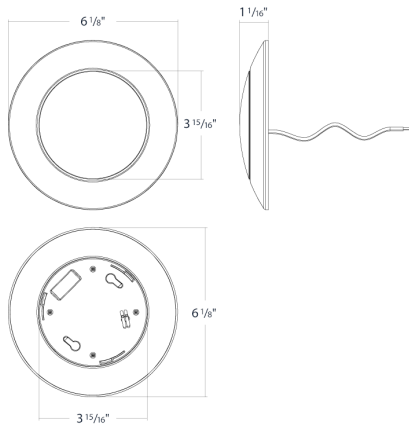

Features

- Ultra low-profile, back-lit design made of durable thermoplastic with frosted lens
- Five selectable color temperatures in each fixture. (2700-3000-3500-4000-5000K)
- Easy surface mount installation with included keyholes and compatible with 3/0 & 4/0 junction boxes
- Designed and Certified to Comply with NEC Code 410.16(A)(3) and NEC Code 410.16(C)(5) for Installation in Closet Storage Space
- Wet Location, Title 24, & Energy Star rated. 5-year warranty
- Packaged in bulk case quantities of 12

Ordering Matrix

Family	Size/Wattage	Shape	CRI/Color Temp	Driver	Finish
DISK17	4				/BP
	4 = 4", 7W 6 = 6", 10W	Blank = Round	Blank = 90 CRI, 2700/3000/3500/4000/5000K CCT Adjustable	Blank = 120V, TRIAC/ELV	Blank = White