

# 6" New Construction Dedicated IC Airtight Housing

6" new construction dedicated LED housing. Compatible with 6" LED inserts. Can include step-down transformer.

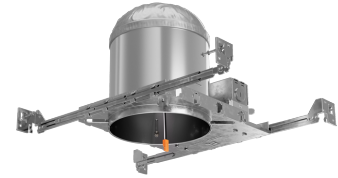

## Features

- IC Airtight for direct contact with insulation.
- With quick connect terminal.
- Transformer (EL770ICA-7 only): 277V to 120V step-down transformer.
- Meets Title 24 requirements. ENERGY STAR® Certified.
- Trims and inserts sold separately.

## Specifications

<b>Wattage</b>	24W MAXW
<b>Voltage</b>	120/277V
<b>Damp Location</b>	Listed

## Dimensions

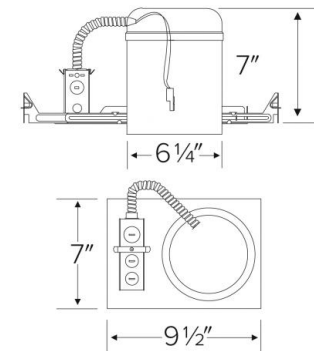

## Technical Details

### Construction:

- Single wall IC rated for direct contact with insulation, for use in IC or non-IC conditions.
- Housing adjusts in frame to accommodate up to 1 1/4" ceiling thickness.
- Airtight housing with gasket to restrict airflow in accordance with ASTM E-283 air-tight requirements.
- Steel housing for greater heat dissipation. Stamped galvanized steel frame.

**Installation:** Designed for ceiling plenums where 2x8 joists or taller joists are used. High strength hanger bars can easily be nailed to joists. Maximum hole cutout is 6 1/4". Suitable for T-grid and drop ceiling applications. See installation sheet for detailed information.

**Junction Box:** Positioned to accommodate straight conduit runs. Seven 1/2" trade size conduit knockouts, four 3/4" knockouts. Pry-out knockout slots. 4 Romex pryouts with strain relief.

**Hanger Bars:** Pre-installed hanger bars with TrueNail facilitate easy installation in regular lumber, engineered lumber, and laminated beams. Integral T-bar slots for easy installation in T-bars. Spans up to 24" and can be repositioned 90°. Score lines allow for tool-free hanger bar size reduction. Integral leveling flange allows for single-person installation while aligning the housings with the joists.

### Electrical:

- Input Voltage: 120V AC.
- Inherently protected.

**Emergency Backup:** The fixture becomes 120V only with the -EM7 Emergency Battery Backup.

**Trims:** Compatible with ELCO 6" LED Inserts.

### Dimmability:

- Dimmability based on lamp.

**Lamp:** Designed for use with ELCO 6" LED inserts, LED modules, or PSA37 with 6" MR16 trims.

### Listings:

- cUL Listed for Damp Location.
- cUL Listed for Wet Location with select trims.
- cUL Listed for Feed Through.
- cUL Listed for Direct Contact with Insulation and Combustible Material.
- Airtight per ASTM E-283.
- Install a JA8-2016-E lamp for Title 24 Compliance.

**Warranty:** ELCO Lighting warrants products will be free from defects in materials and workmanship for a period of 5 years.

## Product Number

Item	Watts	Voltage
EL770ICA	24W MAX	120/277V

# Compatible Products

For use with Dedicated 6" IC LED Housings

## Koto™ LED Module

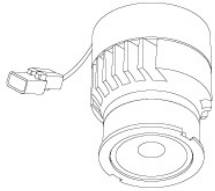

**Koto™ LED Module**  
ELK07, ELK09, & ELK11

### PRODUCT NUMBER BUILDER

Koto™ LED Module	Lumens	Color Temperature	Beam Angle
ELK			
07	750 lm	27 2700K	(blank) 38° lens (Standard)
09	950 lm	30 3000K	-S 18° lens
11	1150 lm	35 3500K	-N 25° lens
		40 4000K	-W 60° lens
		SD Sunset Dimming (For ELK09 & ELK11)	-FC 18° - 50° Adjustable (ELK07 Only)

### ACCESSORIES



#### Lens

- EP731C 18° Lens
  - EP732C 25° Lens
  - EP733C 38° Lens
  - EP734C 60° Lens
- \*EP732C, EP733C, EP734C Included



#### Snoot

- L50W White
- L50B Black



#### Secondary Optics

- L45 Hex Louver
- L46 Linear Lens
- L47 Spread Louver
- L49 Frosted Lens
- L51 Color Shifter

**Koto™ LED Module with 5-CCT Switch**

**Product Number**

ELK08CT5	825 lm
ELK10CT5	1000 lm

## 6" Twist-On Trims



**Pex™ Reflector**

ELK6418

Finishes:  
(W, BB, BZ, H)



**Flexa™ Adjustable Reflector**

ELK629

Finishes:  
(WW, BB, BZBZ, BW, CW, HW)



**Flexa™ Adjustable Baffle**

ELK693

Finishes:  
(WW, BB, BZBZ, BW)



**Unique™ Wall Wash**

ELK6715

Finishes:  
(W, BZ)



**Adjustable Slot Aperture**

ELK6420

Finishes:  
(W)



**Flexa™ Reflector**

ELK610

Finishes:  
(WW, BB, BZBZ, BW, CC, CW, CN, HW)

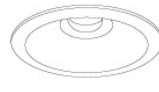

**Unique™ Reflector**

ELK6710

Finishes:  
(W, B, BZ)

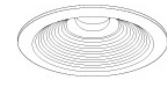

**Unique™ Baffle**

ELK6713

Finishes:  
(W, BZ)

\*Finishes: **W** - All White, **WW** - All White, **B** - Black, **BB** - All Black, **BZ** - All Bronze, **CC** - All Chrome, **BZBZ** - All Bronze, **BW** - Black Reflector w/White Ring, **CW** - Chrome Reflector w/White Ring, **CN** - Chrome Reflector w/Nickel Ring, **HW** - Haze Reflector w/White Ring

# Compatible Products

For use with Dedicated 6" IC LED Housings

## 6" LED Light Engines



**Round Builder Reflector Insert**

CAT NO.	SPECIFICATIONS
EL65527W	10W, 800 lm, 2700K
EL655CT5W	10W, 700 lm, 2700K - 5000K



**Round Reflector**

CAT NO.	SPECIFICATIONS
EL61527W, BZ	10W, 800 lm, 2700K
EL61530W	10W, 850 lm, 3000K
EL61535W	10W, 900 lm, 3500K
EL61540W	10W, 900 lm, 4000K
EL61550W	10W, 950 lm, 5000K
EL615CT5W, BB, BZ	12W, 850 lm - 880 lm, 2700K - 5000K



**Round Reflector**

CAT NO.	SPECIFICATIONS
EL61740W	14W, 1100 lm, 4000K
EL617CT5W	17W, 1100 lm, 2700K - 5000K



**Round Reflector**

CAT NO.	SPECIFICATIONS
EL62727W	20W, 1400 lm, 2700K
EL627CT5W	20W, 1400 lm, 2700K - 5000K



**Round Deep Reflector**

CAT NO.	SPECIFICATIONS
EL62527W, C, H	14W, 1000 lm, 2700K
EL62530C, H	14W, 1000 lm, 3000K
EL62535C, H	14W, 1100 lm, 3500K
EL62540C, H	14W, 1200 lm, 4000K
EL625CT5W, H	15W, 1000 lm, 2700K - 5000K



**DIMS TO WARM** **Round Reflector**

CAT NO.	SPECIFICATIONS
EL615SDW, BZ	10W, 750 lm, Sunset



**Round Baffle**

CAT NO.	SPECIFICATIONS
EL61027W	9W, 800 lm, 2700K
EL61030W	9W, 850 lm, 3000K
EL61040W	9W, 900 lm, 4000K
EL610CT5W, BB	12W, 880 lm, 2700K - 5000K



**Round Baffle**

CAT NO.	SPECIFICATIONS
EL61140W	14W, 1200 lm, 4000K
EL611CT5W	14W, 1200 lm, 2700K - 5000K



**Round Baffle**

CAT NO.	SPECIFICATIONS
EL612CT5W	20W, 1400 lm, 2700K - 5000K

\*Finishes: **W** - All White, **BB** - All Black, **BZ** - All Bronze, **C** - Chrome w/White Ring, **H** - Haze w/White Ring

# Compatible Products

For use with Dedicated 6" IC LED Housings

## 6" LED Light Engines



**Round Adjustable Gimbal**

CAT NO.	SPECIFICATIONS
EL61327W, B	17W, 1100 lm, 2700K
EL61330W, B	17W, 1100 lm, 3000K



**Round Gimbal**

CAT NO.	SPECIFICATIONS
EL616CT3W	13W, 950 lm, 2700K-3500K
EL616CT5W, B, BZ	13W, 1000 lm, 2700K - 5000K



**Round Deep Baffle**

CAT NO.	SPECIFICATIONS
EL62127W	14W, 1000 lm, 2700K
EL621CT5W	15W, 1000 lm, 2700K - 5000K



**Square Reflector**

CAT NO.	SPECIFICATIONS
EL662CT5W	16W, 1300 lm, 2700K - 5000K



**Square Baffle**

CAT NO.	SPECIFICATIONS
EL661CT5W	16W, 1300 lm, 2700K - 5000K



**Round Pull Down Adjustable**

CAT NO.	SPECIFICATIONS
EL69727W, B, BZ,	12.6W, 800 lm, 2700K
EL69730W, B, BZ,	12.6W, 840 lm, 3000K



**Round Pull Down Adjustable (2nd Generation)**

CAT NO.	SPECIFICATIONS
EL69727W2, BZ2	11W, 950 lm, 2700K
EL69730W2, BZ2	11W, 950 lm, 3000K



**Round Adjustable Reflector PAR30 Gimbal**

CAT NO.	SPECIFICATIONS
EL377CT5W, B, C	15W, 1050 lm, 2700K - 5000K



**Round Adjustable Baffle PAR30 Gimbal**

CAT NO.	SPECIFICATIONS
EL376CT5W, B, BZ	15W, 1050 lm, 2700K - 5000K



**Round Adjustable Reflector PAR38 Gimbal**

CAT NO.	SPECIFICATIONS
EL477CT5W, B, C	18W, 1200 lm, 2700K - 5000K



**Round Adjustable Baffle PAR38 Gimbal**

CAT NO.	SPECIFICATIONS
EL476CT5W, B, BZ	18W, 1200 lm, 2700K - 5000K



**6" Round Reflector Insert with 5-CCT Switch & 3-Lumen Switch**

CAT NO.	SPECIFICATIONS
EL637CT5W, BB	14W, 18W, 24W, 1000 - 1500 - 2000 lm, 2700K - 5000K

\*Finishes: **W** - All White, **B** - Black, **B** - Black w/White Ring **BZ** - All Bronze, **C** - Chrome w/White Ring

# Compatible Products

For use with Dedicated 6" IC LED Housings



## 6" Cedar™ LED Light Engines



**Round Reflector**

**E610R**

Finishes:

(W, B, BZ, C, G, H)



**Round Drop Glass**

**E612R**

Finishes:

(W, B, BZ, C, G, H)



**Round Baffle**

**E614R**

Finishes:

(W, B, BZ)



**Round Adjustable Baffle**

**E616R**

Finishes:

(W, B, BZ)



**Round Adjustable Reflector**

**E617R**

Finishes:

(W, B, BZ, C, H)

### PRODUCT NUMBER BUILDER

6" LED Module & Driver	Style	Lumens	Color Temperature	Finish
<b>E6</b>				
<b>10R</b>	Round Reflector	<b>08</b> 850 lm (10.5W)	<b>27</b> 2700K	<b>W</b> All White
<b>12R</b>	Round Drop Glass	<b>12</b> 1250 lm (15.7W)	<b>30</b> 3000K	<b>B</b> Black w/White Ring
<b>14R</b>	Round Baffle		<b>35</b> 3500K	<b>BZ</b> All Bronze
<b>16R</b>	Round Adjustable Baffle		<b>40</b> 4000K	<b>C</b> Chrome w/White Ring
<b>17R</b>	Round Adjustable Reflector		<b>50</b> 5000K	<b>G</b> Gold w/White Ring
			<b>SD</b> Sunset Dimming	<b>H</b> Haze w/White Ring

# Compatible Products



For use with Dedicated 6" IC LED Housings

## 6" Ply™ 120/277V LED Inserts



**Round Insert with 5-CCT and 3-Lumen Switch**

**EL685CT5D**

Finishes:  
**(W, BB, CW, HW)**



**Round Insert**

**EL695**

Finishes:  
**(DCW)**

\*Finishes: **W** - All White, **BB** - All Black, **H** - All Haze, **HW** - Haze w/White Ring

\*Must be used with PLY™ Housings for 0-10V dimmability (EL770ICDXA, EL770RICDXA, EL76FICDXA, EL760ICDXA, EL760RICDXA).  
With non-ply housing this is non-dimmable, 120-277V input only.

## 6" Ply™ 120/277V Adjustable LED Inserts



**Round Adjustable Pull Down**

**EL697**

Finishes:  
**(DXW, DXB, DXBZ)**

### ACCESSORIES



**Interchangeable Lens**  
(For EL697 Series only)

**EP710C** 20° Beam  
**EP712C** 60° Beam

### PRODUCT NUMBER BUILDER

6" 120/277V Adjustable LED Inserts	Style	Color Temperature	Finish
<b>EL6</b>	<b>97</b> Round Adjustable	<b>27D</b> 2700K (850 lm) <b>30D</b> 3000K (900 lm)	<b>DXW</b> All White <b>DXB</b> All Black <b>DXBZ</b> All Bronze

\*Must be used with PLY™ Housings for 0-10V dimmability (EL770ICDXA, EL770RICDXA, EL76FICDXA, EL760ICDXA, EL760RICDXA).  
With non-ply housing this is non-dimmable, 120-277V input only.

## 6" Accessories

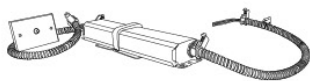

**Emergency Battery Backup**



**Fire Cover**

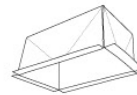

**Fire Enclosure**



**Mica Fire Tape**

CAT NO.	SPECIFICATIONS	CAT NO.	SPECIFICATIONS	CAT NO.	SPECIFICATIONS	CAT NO.	SPECIFICATIONS
KEM-LD5	8W, 120/277V	FIRECVR	9 3/4" H x 17" O.D.	FIREENCL	20 3/8" L x 14 3/8" W	FIRETAPE	3/4" W x 16' L
				FIREENCL-S	Shallow, 16" L x 14 3/8" W		