

Project Name:	Type:
Part Number:	Date:

# 8W EMERGENCY LED INVERTER

## FEATURES

- Suitable for use with select GREEN CREATIVE fixtures and lamps. For details of compatibility with specific product models, please refer to the Products Emergency Compatibility Matrix file available on <https://greencreative.com/emergency-accessories/>
- Suit for 5W to 80W LED product with 0-10V dimming driver (Ensure that the system power is below 6W when dimming to 1V). Suit for 5W to 8W LED product without 0-10V dimming function.
- Constant 8W power output during emergency mode.
- LiFePO4 12.8V Battery pack with 1600mAh capacity (20.48Wh)
- One-piece metal housing provided for easy connection.
- 23-5/8" flex conduit suitable for fitting into 1/2" knockouts.
- Includes 2in1 test switch with indicator light.
- Input voltage: 100-277V AC, 50/60Hz
- Low Voltage Disconnect (LVD): 120-200V
- Constant power output in emergency mode for a minimum of 90 minutes
- Recyclable long-life high-temperature Lithium-ion battery
- Meets or exceeds all National Electrical Code and Life Safety Code Emergency Lighting Requirements
- EM Inverter ambient temperature: 50°F to 140°F (10°C to 60°C)
- Integral short circuit protection
- 5 year limited warranty\*
- UL 924 Listed, cUL Listed to CSA C22 No. 141
- Rated for use in dry or damp locations

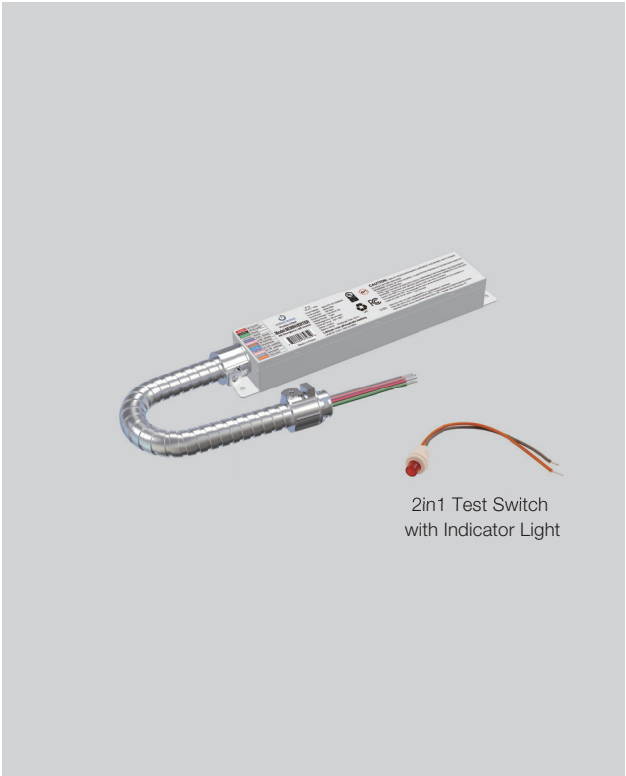

062824



## SPECIFICATIONS

Product	37934
Model	8EMINVERTER
Input Voltage	100-277V AC, 50/60Hz
Input Current	80mA Max
Input Power	5W Max
Output Power	8W Max
Output Voltage	120-200Vdc
Charge Time	24 hours
Emergency Run Time	90 minutes
Ambient Temperature	50°F to 140°F (10°C to 60°C)
Battery	LiFePO4 12.8V 1.6Ah
Approval	UL 924 Listed, cUL Listed to CSA C22 No. 141, CEC Compliant

\* Please visit [www.greencreative.com](http://www.greencreative.com) for Limited Warranty terms.

## DIMENSION & WEIGHT

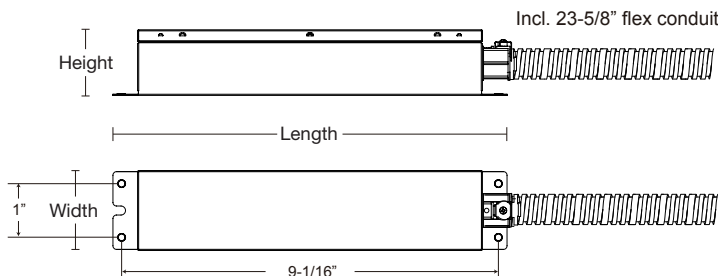

Model	8EMINVERTER
Length	9-1/2"
Width	1-3/4"
Height	1-3/16"
Weight	1.0 lb





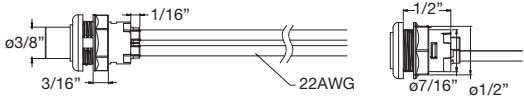

# 8W EMERGENCY LED INVERTER

## SUPPLIED ACCESSORY

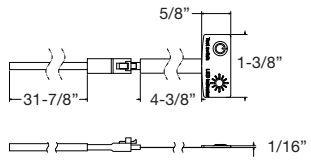
Product	Model	Description	Picture	Dimensions
N.A.	EM Indicator	2in1 Test switch with indicator light		

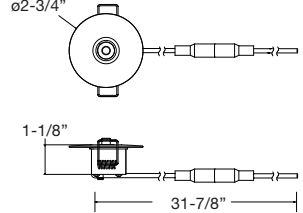
## OPTIONAL ACCESSORY ORDERING INFORMATION

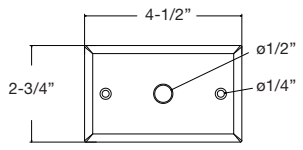
Product	Model	Description	Picture	Dimensions
37936	TAPETESTACC	Adhesive Field Fixture Mount Test Switch and Indicator Light		
37937	CEILTESTACC	Remote Round Ceiling Mount Test Switch and Indicator Light		
37938	WALLPLATE	Single Gang Jbox Face Plate		

## INSTALLATION

### Emergency Inverter

1. Turn off power at the source.
2. Attach the emergency LED inverter to the fixture or ceiling, ensuring it doesn't interfere with existing hardware.
3. Ensure installation complies with local regulations.
4. If using switched power, ensure an unswitched line is available in the J-box or fixture wiring compartment.
5. If using unswitched constant power applications (emergency only), connect the incoming unswitched line to the unit's black wire and cap off the unit's black/white switched line.
6. Connect the flex conduit for line voltage to the J-box or fixture wiring compartment as per the wiring diagram. Pair the unit connector last to prevent electric shock.
7. Wire the test accessory plate according to the wiring diagram, ensuring correct connections for the indicator light and test switch.
8. Restore power at the source to complete the installation.



# 8W EMERGENCY LED INVERTER

## INSTALLATION

### Accessory - 2in1 Test Switch with Indicator Light (Supplied)

1. Pre-open a 1/2 " hole on the fixture housing and fix the test button on the fixture housing (Figure 1-1).
2. Wire the test button to EM inverter Indicator & Test button wires (Figure 1-2).

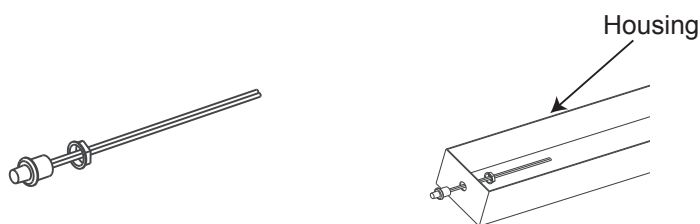

Figure 1-1

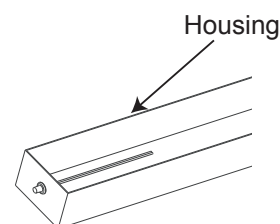

Figure 1-2

#### Indicator Light:

Red On: Charging / Fully Charged

Off: Emergency Mode / Open Circuit / LED Load Exceeds Nominal Emergency Power

2-Second Slow Flashing: Indicates the need for charging or compatibility testing in standby mode. If it continues to flash slowly after being charged (within 24 hours), it suggests incompatibility with fixtures.

0.5-Second Fast Flashing: Signifies a failure, indicating a lack of connection to power or load. It is recommended to check the wiring in such cases.

#### Test switch:

Activating the test switch while the main power supply is on will cause the Emergency Conversion Kit to enter emergency mode. Conversely, it will enter charging mode if the test switch is not pressed.

To exit the emergency mode, press the test switch for a duration of 3 seconds while in emergency mode.

### Accessory - Single Gang Jbox Face Plate (Optional)

1. Attach the indicator to the Single Gang Jbox Face Plate (refer to Figure 2-1).
2. Connect the indicator wire to the inverter located within the junction box (not included).
3. Securely fasten the plate onto the junction box using 2 screws (refer to Figure 2-2).

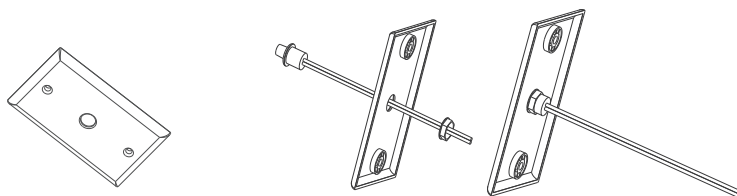

Figure 2-1

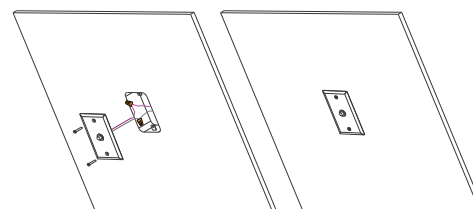

Figure 2-2



# 8W EMERGENCY LED INVERTER

## INSTALLATION

### Accessory - Remote Round Ceiling Mount Test Switch and Indicator Light (Optional)

1. Disconnect the quick connector of the Remote Round Ceiling Mount Test Switch and Indicator Light (refer to Figure 3-1).
2. Create a hole in the ceiling with a diameter between 2" and 2 3/8", then route the indicator cord to the inverter within the junction box (not included) and reconnect the quick connector (refer to Figure 3-2).
3. Pinch the 2 springs, insert them into the ceiling hole, and release the springs (refer to Figure 3-3).

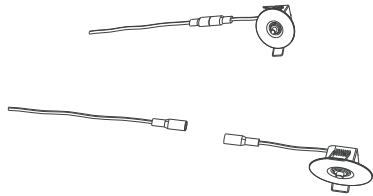

Figure 3-1

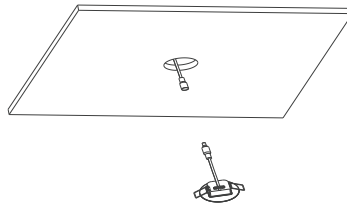

Figure 3-2

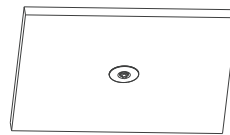
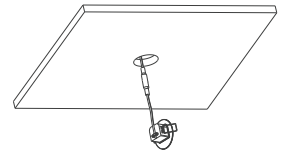

Figure 3-3

### Accessory - Adhesive Field Fixture Mount Test Switch and Indicator Light (Optional)

1. Disconnect the quick connector of the Adhesive Field Fixture Mount Test Switch and Indicator Light (refer to Figure 4-1).
2. Attach the test indicator to the fixture surface using the included double-sided sticker (refer to Figure 4-2).
3. Connect the indicator cord to the inverter within the junction box (not included).
4. Plug in the quick connector and proceed to follow the standard fixture installation instructions to finalize the installation (refer to Figure 4-3).

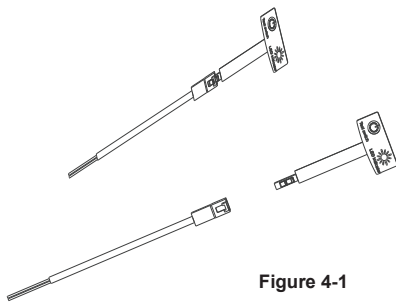

Figure 4-1

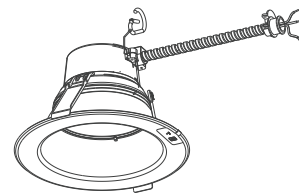

Figure 4-2

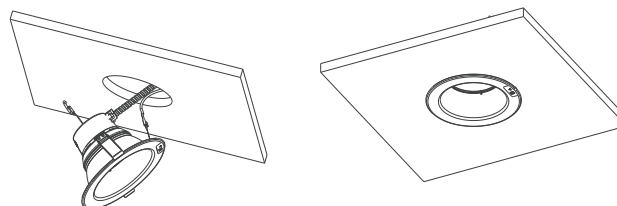
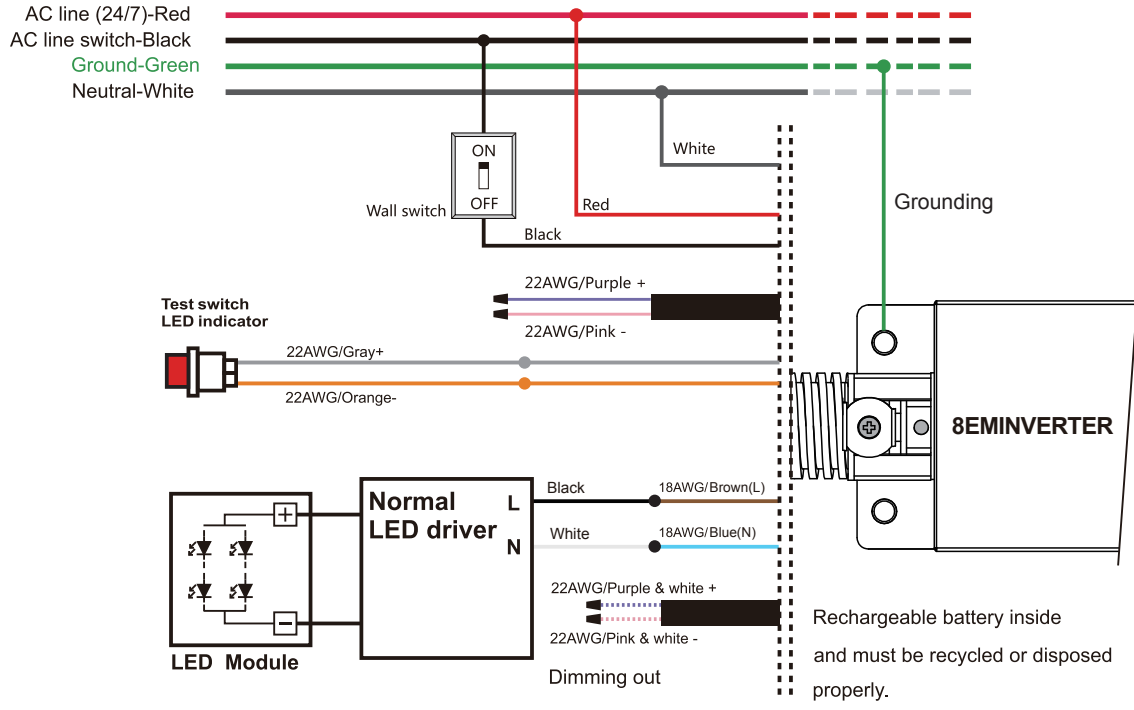

Figure 4-3



# 8W EMERGENCY LED INVERTER

## WIRING DIAGRAM



Cap off 0-10V wires for fixtures without dimming

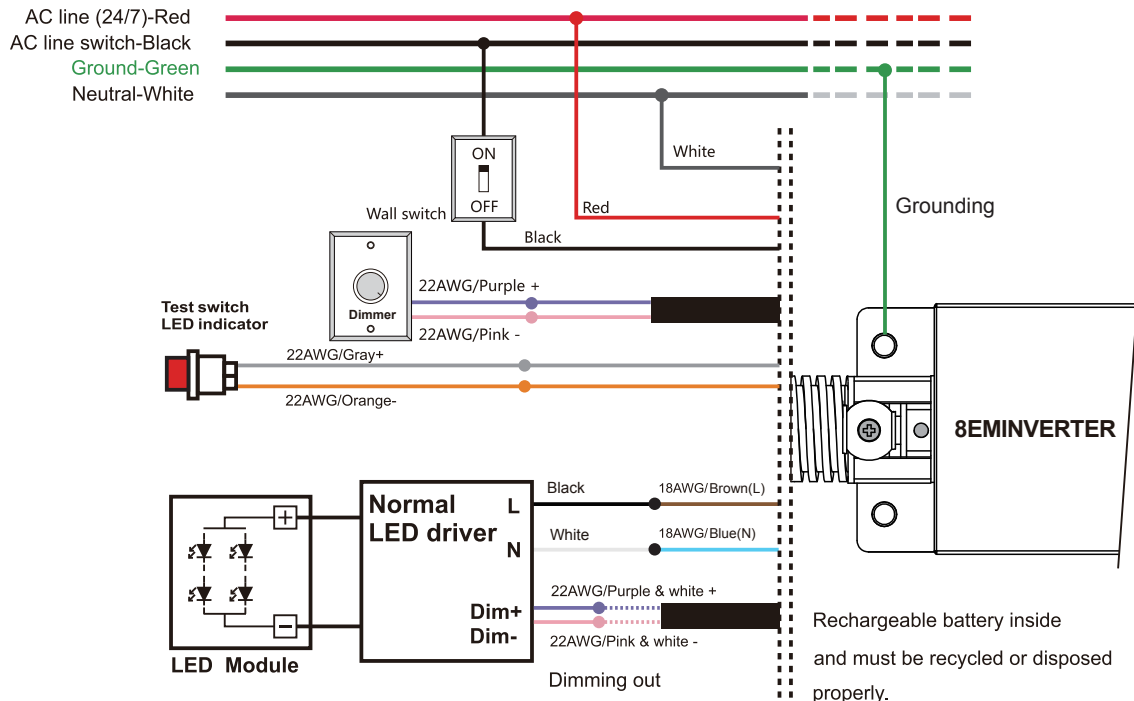

Fixtures with 0-10V dimming



# 8W EMERGENCY LED INVERTER

## ORDERING INFORMATION

Model	Master Carton			Shipping Carton		
	Case Qty	Case Dimensions (LxWxH)	Case Weight	Case Qty	Case Dimensions (LxWxH)	Case Weight
8EMINVERTER	N.A	N.A	N.A	10 PCS	26-3/4" x 8-11/16" x 6-5/16"	19.8 lbs
TAPETESTACC	N.A	N.A	N.A	48 PCS	7-1/2" x 7-1/16"x 8-3/8"	3.96 lb
CEILTESTACC	N.A	N.A	N.A	48 PCS	19-1/2"x 15-3/8"x 6-1/8"	8.8 lb
WALLPLATE	N.A	N.A	N.A	48 PCS	7-1/2" x 7-1/16"x 8-3/8"	5.28 lb

Note: All rights reserved. All sizes and specifications are subject to change at any time without notice