



Color: Black

Weight: 4.7 lbs

Project:

Type:

Prepared By:

Date:

Driver Info

Type	Constant Current
120V	1.40A/1.20A/1.00A
208V	0.80A/0.70A/0.60A
240V	0.70A/0.60A/0.50A
277V	0.60A/0.50A/0.40A
Input Watts	101-149.1W

LED Info

Watts	150/120/100W
Color Temp	3000/4000/5000K
Color Accuracy	83-86 CRI
L70 Lifespan	100,000 Hours
Lumens	15,317-22,224 lm
Efficacy	140.1-168.8 lm/W

Technical Specifications

Field Adjustability

Field Adjustable:

Field Adjustable Light Output:
150W/120W/100W (factory default 150W)
Color temperature selectable by 3000K, 4000K and 5000K (factory default 4000K)

Compliance

UL Listed:

Suitable for wet locations

IESNA LM-79 & LM-80 Testing:

RAB LED luminaires and LED components have been tested by an independent laboratory in accordance with IESNA LM-79 and LM-80.

IP Rating:

Ingress protection rating of IP65 for dust and water

Certification Model Number:

H17-002

DLC Listed:

This product is listed by Design Lights Consortium (DLC) as an ultra-efficient premium product that qualifies for the highest tier of rebates from DLC Member Utilities. Designed to meet DLC 5.1 requirements.
DLC Product Code: S-AXTFS7

Electrical

Driver:

150W: Constant Current, Class 1, 120-277V, 50/60Hz, 120V: 1.25A, 208V: 0.72A, 240V: 0.63A, 277V: 0.54A
120W: Constant Current, Class 1, 120-277V, 50/60Hz, 120V: 1.00A, 208V: 0.58A, 240V: 0.50A, 277V: 0.43A
100W: Constant Current, Class 1, 120-277V, 50/60Hz, 120V: 0.83A, 208V: 0.48A, 240V: 0.42A, 277V: 0.36A

Dimming Driver:

Driver includes wiring for 0-10V dimming systems.
Dim as low as 10%.

THD:

3.25% at 120V, 5.6% at 277V

Power Factor:

99.71% at 120V, 93.05% at 277V

Surge Protection:

L-N: 4kV
L/N-PE: 6kV

LED Characteristics

LEDs:

Long-life, high-efficacy, surface-mount LEDs

Color Consistency:

7-step MacAdam Ellipse binning to achieve consistent fixture-to-fixture color

Color Uniformity:

RAB's range of Correlated Color Temperature follows the guidelines of the American National Standard for Specifications for the Chromaticity of Solid State Lighting (SSL) Products, ANSI C78.377-2017.

Construction

Cold Weather Starting:

The minimum starting temperature is -40°C (-40°F)

Ambient Temperature :

Max Power Temp Rating: 50°C (122°F)
Middle Power Temp Rating: 57°C (135°F)
Low Power Temp Rating: 63°C (145°F)

Housing:

Precision die-cast aluminum

Lens:

Polycarbonate lens

Reflector:

Polycarbonate and Aluminum (Reflector Accessories Sold Separately)

Cord & Plug:

6 ft cord and NEMA 5-15P plug for 120V only

Technical Specifications (continued)

Finish:

Formulated for high durability and long-lasting color

Green Technology:

Mercury and UV free. RoHS-compliant components.

Installation

Mounting:

Comes standard with a hanging hook and a 6-foot cord. Heavy-duty 3/4"-14 NPT hook and 3/4"-14 pendant mount capable (pendant by others)

Other

Compatible Products:

[H17 Field-Adjustable High Bay Accessories](#)

5 Yr Limited Warranty:

The RAB 5-year, limited warranty covers light output, driver performance and paint finish. RAB's warranty is subject to all terms and conditions found at rablighting.com/warranty.

Performance

Wattage Equivalency:

Equivalent to 400W Metal Halide

Dimensions

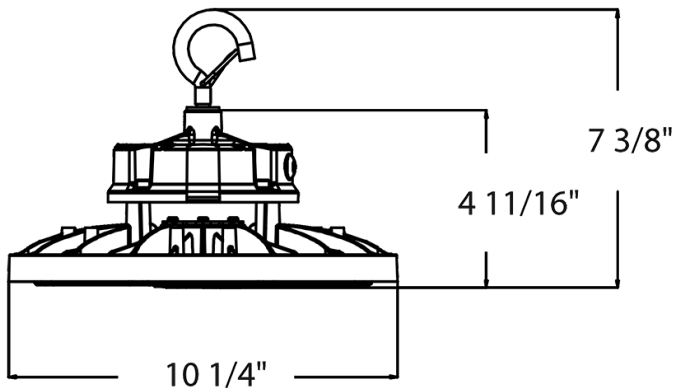

Features

- DLC Premium listed
- 100,000-hour LED Life
- 0-10V dimming standard
- 5-Year, limited warranty

Ordering Matrix

Family	Wattage	Mounting	Color Temp	Finish	Driver	Options
H17	S = 100/80/60W Blank = 150/120/100W XL = 240/200/150W XXL = 500/400/300W	Blank = Hook	Blank = 3000/4000/5000K CCT Adjustable	B = Black Blank = White	Blank = 120-277V, 0-10V Dimming /480 = 480V, 0-10V Dimming	Blank = No Option /6CP = 6' Cord & 120V Plug /6CP2 = 6' Cord & 277V Plug /6CPT4 = 6' Cord & 480V Plug /LCBS = Lightcloud Blue w/PIR Sensor