

# KT-LALEDXXPS-YA-8CSF-VDIM-X

## LED LINEAR PENDANT FIXTURE

### DESCRIPTION

Linear Architectural LED Fixture with Direct/Indirect Lighting | Power and Color Selectable | 120-277V Input | 0-10V Dim with 12V AUX

### APPLICATION

Indoor Illumination needs for Office, Education, Healthcare, Hospitality and Retail settings with a wide variety of installation options



**10 YEAR LIMITED WARRANTY**

### PRODUCT FEATURES

- Modern architectural linear fixture with an unparalleled blend of flexible performance specs, attractive design, and easy modular linking to meet diverse requirements from general purpose to specification grade applications. Available in 2', 3', 4' and 8' lengths.
- Extruded Aluminum Housing & internal wiring designed for modular tool-free assembly allows installers to quickly and seamlessly link fixtures to create continuous rows of illumination.
- Select between Direct and Direct/Indirect lighting modes to suit lighting needs. (100% down, 70% down/30% up, 50% down/50% up)
- All fixtures are Power & Color Selectable with up to 130 lm/W offers class leading efficiency for maximum energy savings
- Powered by Keystone 0-10V Dimming LED driver with Dim-to-Off & 12V AUX power tap
- Diffused polycarbonate lens provide uniform illumination and lit appearance
- Each Fixture includes a standard 15' aircraft mounting cable kit for suspension mount installations and options for both fixed cable grippers and adjustable cable grippers that slide along with length of the fixture, to allow for flexible ceiling mount locations
- Wide variety of cable mount canopy accessories available (sold separately) for feed and non-feed kits to cover a wide variety of installations needs including J-Box mount, surface/drywall mount, T-Bar Mount, and Masonry Mount
- Optional 32' roll out monolithic lens (sold separately) for a seamless lens on continuous runs. Field installable and can be cut to length as needed
- Optional recessed, wall, and surface mounting kits available (sold separately) add versatility for a wide range of applications
- Optional Smartloop Wireless occupancy sensor end cap to mount KTSL-FC2-12V-SM-PIR
- Compatible with Keystone SmartSafe emergency LED drivers (4' and 8' only)
- UL Certified for dry or damp locations
- LED chip lifetime: L70 >100,000 hrs @ 25C°/77F° ambient fixture temp
- Power Factor >0.95, THD:<20%
- Ambient operating temperature: -40°C/-40°F to 50°C/122°F (pessant and wall only. Recessed mount Max of 40C)
- Meets FCC Part 15, Part B, Class A standards for conducted and radiated emissions

### PRODUCT SPECIFICATIONS

Catalog Number	Nominal Size	Selectable Wattage	Selectable CCT	Max Lumens	Nominal Efficacy	Input Voltage	Dimmable	CRI	Lifetime	Housing Color
KT-LALED20PS-2A-8CSF-VDIM	2'	20W / 15W / 12W	2700K 3000K 3500K 4000K 5000K	2600	130 lm/W	120-277V	0-10V	>80	50,000 hrs	White
KT-LALED20PS-2A-8CSF-VDIM-B										Black
KT-LALED30PS-3A-8CSF-VDIM	3'	30W / 23W / 18W		3900						White
KT-LALED80PS-8A-8CSF-VDIM-B				Black						
KT-LALED40PS-4A-8CSF-VDIM	4'	40W / 30W / 25W		5200						White
KT-LALED40PS-4A-8CSF-VDIM-B				Black						
KT-LALED80PS-8A-8CSF-VDIM	8'	80W / 60W / 50W		10400						White
KT-LALED80PS-8A-8CSF-VDIM-B				Black						

\* Fixture Pre-set to highest Wattage & 5000K

\*\*Color Uniformity: CCT (Correlated Color Temperature) range as per guidelines outlined in ANSI C78.377-2017

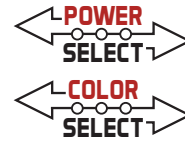

# KT-LALEDXXPS-YA-8CSF-VDIM-X

## LED LINEAR PENDANT FIXTURE

### EASY LINKABLE FUNCTION

- These fixtures are designed to be easily linkable / daisychained in any variety of lengths, so long as the total connected load (per power feed) does not exceed the following conditions:
  1. 7 fixtures max
  2. Total connected load is <math><420W</math> at 120V and <math><960W</math> at 277V

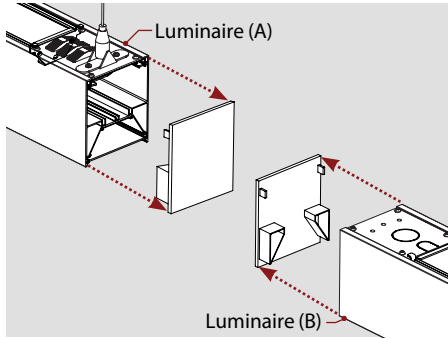

**Step 1.** Remove End Caps and open the topside of the fixture

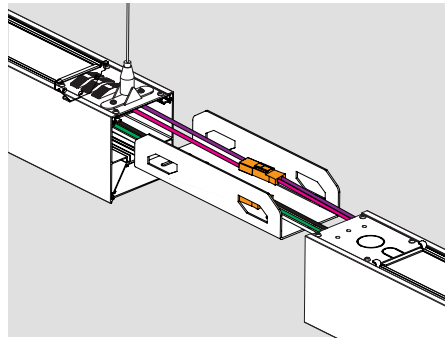

**Step 2.** Insert Linking Bracket, Connect wiring via included quick connects, Slide Fixture together, and fasten bracket with included buckles

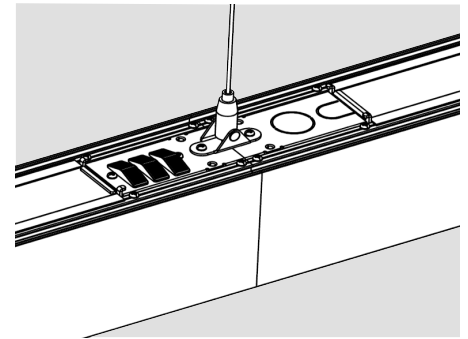

**Step 3.** Install suitable suspension hardware ((1) fixed aircraft cable gripper bridged across the fixture seam is recommended)

#### Single Direction

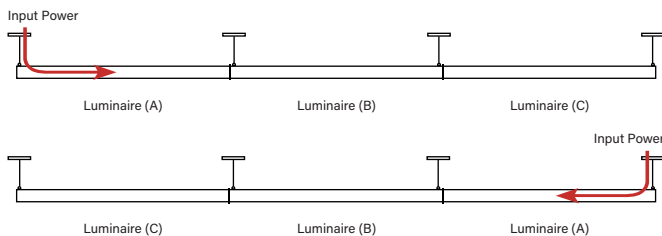

#### Multi-Direction

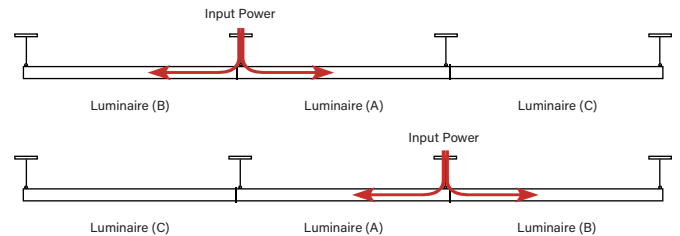

\* For Multi-Direction wiring requires use of wiring harness accessory (KT-LALED-WH-MD-KIT).

### WHATS INCLUDED

#### Each Fixture Comes with the following

- (1) Fixture Body
- (1) Standard Aircraft Cable Hanging Kit (Use as desired)
  - » (2) 15' aircraft cables with tapped base coupler & hardware (for surface mount)
  - » (2) 15' aircraft cables with looped end
  - » (2) Fixed aircraft cable grippers
  - » (2) Adjustable "Y" cable grippers
- (1) Fixture Linking Bracket (Not used for single fixture installs)



#### Hanging using fixed aircraft cable grippers

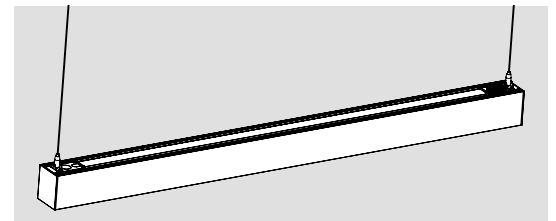

#### Hanging using adjustable "Y" cable grippers

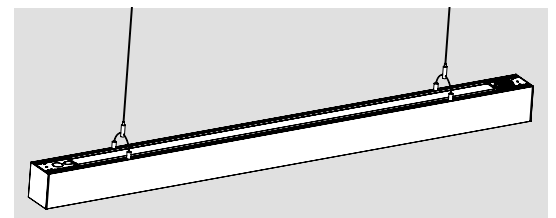

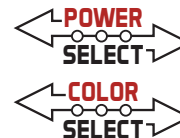

# KT-LALEDXXPS-YA-8CSF-VDIM-X

## LED LINEAR PENDANT FIXTURE

### SELECTABLE SETTINGS

- Keystone Power Select Technology: Select between 3 different wattage settings per fixture
- Keystone Color Select Technology: Select between 5 different CCT settings per fixture (2700K, 3000K, 3500K, 4000K, 5000K)
- Select Lighting Mode: 100% down, 70% down/30% up, 50% down/50% up

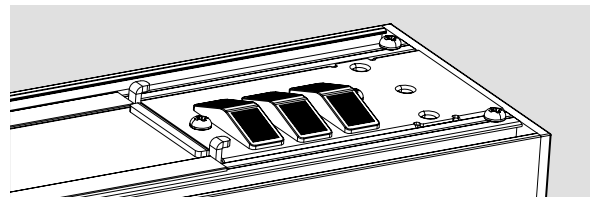

### DETAILED PRODUCT SPECIFICATIONS & PHOTOMETRICS

#### NOMINAL VALUES PER FOOT

Selectable Wattage	Lumens					
	Lighting Mode					
	100% Downlight / 0% Uplight		70% Downlight / 30% Uplight		50% Downlight / 50% Uplight	
	Down	Up	Down	Up	Down	Up
10W	1300	0	910	390	650	650
7.5W	975	0	683	293	488	488
6.25W	813	0	569	244	406	406

Catalog Number		KT-LALED20PS-2A-8CSF-VDIM															
Nominal Size		2'															
Selectable Wattage		20W					15W					12W					
Selectable CCT		2700K	3000K	3500K	4000K	5000K	2700K	3000K	3500K	4000K	5000K	2700K	3000K	3500K	4000K	5000K	
Lumens	100% Downlight / 0% Uplight	Down	2400	2500	2620	2660	2640	1800	1875	1965	1995	1980	1440	1500	1572	1596	1584
		Up	0	0	0	0	0	0	0	0	0	0	0	0	0	0	0
	70% Downlight / 30% Uplight	Down	1680	1750	1834	1862	1848	1260	1313	1376	1397	1386	1008	1050	1100	1117	1109
		Up	720	750	786	798	792	540	563	590	599	594	432	450	472	479	475
	50% Downlight / 50% Uplight	Down	1200	1250	1310	1330	1320	900	938	983	998	990	720	750	786	798	792
		Up	1200	1250	1310	1330	1320	900	938	983	998	990	720	750	786	798	792
Efficacy		120	125	131	133	132	120	125	131	133	132	120	125	131	133	132	

#### ZONAL LUMEN SUMMARY

Down/Up	50/50						70/30						100/0					
	0-30	0-40	0-60	0-90	90-180	0-180	0-30	0-40	0-60	0-90	90-180	0-180	0-30	0-40	0-60	0-90	90-180	0-180
Lumens	418	677	1167	1452	1409	2861	586	947	1632	2032	846	2878	801	1296	2238	2794	0	2794
% Luminaire	14.6%	23.7%	40.8%	50.8%	49.2%	100%	20.4%	32.9%	56.7%	70.6%	29.4%	100%	28.7%	46.4%	80.1%	100%	0.0%	100%

#### ISOCANDELA PLOT

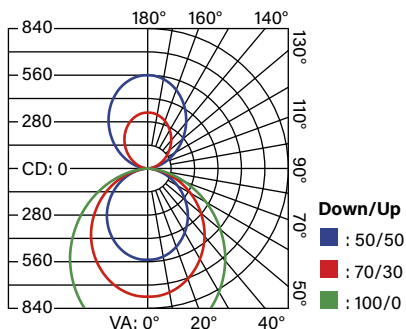

#### CANDELA TABLE (50/50)

Vertical Angle	Candela
0	550
5	549
15	524
25	477
35	413
45	337

#### CANDELA TABLE (70/30)

Vertical Angle	Candela
0	771
5	768
15	733
25	667
35	577
45	471

#### CANDELA TABLE (100/0)

Vertical Angle	Candela
0	1054
5	1051
15	1001
25	910
35	788
45	643

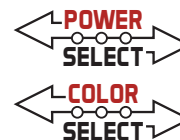

# KT-LALEDXXPS-YA-8CSF-VDIM-X

## LED LINEAR PENDANT FIXTURE

### DETAILED PRODUCT SPECIFICATIONS & PHOTOMETRICS (continued)

Catalog Number		KT-LALED30PS-3A-8CSF-VDIM															
Nominal Size		3'															
Selectable Wattage		30W					23W					18W					
Selectable CCT		2700K	3000K	3500K	4000K	5000K	2700K	3000K	3500K	4000K	5000K	2700K	3000K	3500K	4000K	5000K	
Lumens	100% Downlight / 0% Uplight	Down	3600	3750	3930	3990	3960	2760	2875	3013	3059	3036	2160	2250	2358	2394	2376
		Up	0	0	0	0	0	0	0	0	0	0	0	0	0	0	0
	70% Downlight / 30% Uplight	Down	2520	2625	2751	2793	2772	1932	2013	2109	2141	2125	1512	1575	1651	1676	1663
		Up	1080	1125	1179	1197	1188	828	863	904	918	911	648	675	707	718	713
	50% Downlight / 50% Uplight	Down	1800	1875	1965	1995	1980	1380	1438	1507	1530	1518	1080	1125	1179	1197	1188
		Up	1800	1875	1965	1995	1980	1380	1438	1507	1530	1518	1080	1125	1179	1197	1188
Efficacy		120	125	131	133	132	120	125	131	133	132	120	125	131	133	132	

### ZONAL LUMEN SUMMARY

Down/Up	50/50						70/30						100/0					
Zone	0-30	0-40	0-60	0-90	90-180	0-180	0-30	0-40	0-60	0-90	90-180	0-180	0-30	0-40	0-60	0-90	90-180	0-180
Lumens	626	1010	1736	2156	2112	4268	877	1415	2431	3019	1272	4291	1196	1932	3327	4144	0	4144
% Luminaire	14.7%	23.7%	40.7%	50.5%	49.5%	100%	20.4%	33.0%	56.7%	70.4%	29.6%	100%	28.9%	46.6%	80.3%	100%	0.0%	100%

### ISOCANDELA PLOT

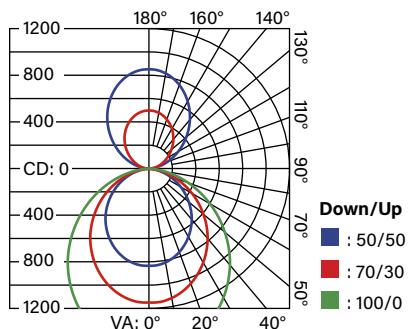

### CANDELA TABLE (50/50)

Vertical Angle	Candela
0	825
5	824
15	786
25	713
35	615
45	500

### CANDELA TABLE (70/30)

Vertical Angle	Candela
0	1156
5	1155
15	1101
25	998
35	861
45	699

### CANDELA TABLE (100/0)

Vertical Angle	Candela
0	1577
5	1574
15	1499
25	1359
35	1172
45	953

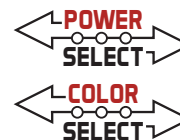

# KT-LALEDXXPS-YA-8CSF-VDIM-X

## LED LINEAR PENDANT FIXTURE

### DETAILED PRODUCT SPECIFICATIONS & PHOTOMETRICS (continued)

Catalog Number		KT-LALED40PS-4A-8CSF-VDIM															
Nominal Size		4'															
Selectable Wattage		40W					30W					25W					
Selectable CCT		2700K	3000K	3500K	4000K	5000K	2700K	3000K	3500K	4000K	5000K	2700K	3000K	3500K	4000K	5000K	
Lumens	100% Downlight / 0% Uplight	Down	5200	5200	5240	5320	5280	3900	3900	3930	3990	3960	3250	3250	3275	3325	3300
		Up	0	0	0	0	0	0	0	0	0	0	0	0	0	0	0
	70% Downlight / 30% Uplight	Down	3640	3640	3668	3724	3696	2730	2730	2751	2793	2772	2275	2275	2293	2328	2310
		Up	1560	1560	1572	1596	1584	1170	1170	1179	1197	1188	975	975	983	998	990
	50% Downlight / 50% Uplight	Down	2600	2600	2620	2660	2640	1950	1950	1965	1995	1980	1625	1625	1638	1663	1650
		Up	2600	2600	2620	2660	2640	1950	1950	1965	1995	1980	1625	1625	1638	1663	1650
Efficacy		130	130	131	133	132	130	130	131	132	132	130	130	131	133	132	

### ZONAL LUMEN SUMMARY

Down/Up	50/50						70/30						100/0					
Zone	0-30	0-40	0-60	0-90	90-180	0-180	0-30	0-40	0-60	0-90	90-180	0-180	0-30	0-40	0-60	0-90	90-180	0-180
Lumens	817	1320	2275	2831	2821	5652	1144	1850	3187	3967	1694	5662	1579	2552	4396	5469	0	5469
% Luminaire	14.4%	23.4%	40.2%	50.1%	49.9%	100%	20.2%	32.7%	56.3%	70.1%	29.9%	100%	28.9%	46.7%	80.4%	100%	0.0%	100%

### ISOCANDELA PLOT

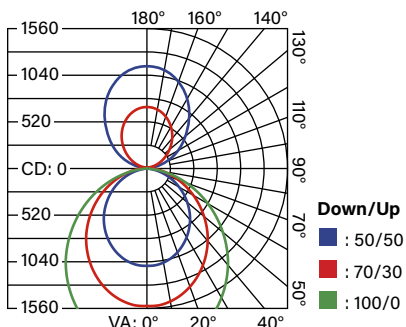

### CANDELA TABLE (50/50)

Vertical Angle	Candela
0	1074
5	1074
15	1025
25	932
35	806
45	656

### CANDELA TABLE (70/30)

Vertical Angle	Candela
0	1506
5	1506
15	1436
25	1305
35	1129
45	919

### CANDELA TABLE (100/0)

Vertical Angle	Candela
0	2080
5	2079
15	1982
25	1801
35	1557
45	1268

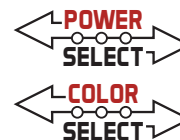

# KT-LALEDXXPS-YA-8CSF-VDIM-X

## LED LINEAR PENDANT FIXTURE

### DETAILED PRODUCT SPECIFICATIONS & PHOTOMETRICS (continued)

Catalog Number		KT-LALED80PS-8A-8CSF-VDIM															
Nominal Size		8'															
Selectable Wattage		80W					60W					50W					
Selectable CCT		2700K	3000K	3500K	4000K	5000K	2700K	3000K	3500K	4000K	5000K	2700K	3000K	3500K	4000K	5000K	
Lumens	100% Downlight / 0% Uplight	Down	10400	10400	10480	10640	10560	7800	7800	7860	7980	7920	6500	6500	6550	6650	660
		Up	0	0	0	0	0	0	0	0	0	0	0	0	0	0	0
	70% Downlight / 30% Uplight	Down	7280	7280	7336	7448	7392	5460	5460	5502	5586	5544	4550	4550	4585	4655	4620
		Up	3120	3120	3144	3192	3168	2340	2340	2358	2394	2376	1950	1950	1965	1995	1980
	50% Downlight / 50% Uplight	Down	5200	5200	5240	5320	5280	3900	3900	3930	3990	3960	3250	3250	3275	3325	3300
		Up	5200	5200	5240	5320	5280	3900	3900	3930	3990	3960	3250	3250	3275	3325	3300
Efficacy		130	130	131	133	132	130	130	131	133	132	130	130	131	133	132	

### ZONAL LUMEN SUMMARY

Down/Up	50/50						70/30						100/0					
Zone	0-30	0-40	0-60	0-90	90-180	0-180	0-30	0-40	0-60	0-90	90-180	0-180	0-30	0-40	0-60	0-90	90-180	0-180
Lumens	1633	2640	4549	5662	5641	11304	2289	3700	6374	7934	3389	11323	3158	5104	8791	10938	0	10938
% Luminaire	14.4%	23.4%	40.2%	50.1%	49.9%	100%	20.2%	32.7%	56.3%	70.1%	29.9%	100%	28.9%	46.7%	80.4%	100%	0.0%	100%

### ISOCANDELA PLOT

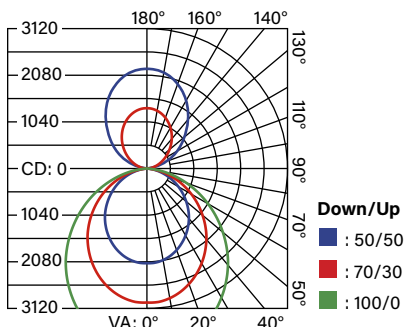

### CANDELA TABLE (50/50)

Vertical Angle	Candela
0	2148
5	2148
15	2050
25	1863
35	1613
45	1313

### CANDELA TABLE (70/30)

Vertical Angle	Candela
0	3012
5	3012
15	2872
25	2610
35	2259
45	1838

### CANDELA TABLE (100/0)

Vertical Angle	Candela
0	4159
5	4159
15	3963
25	3601
35	3114
45	2535

### PHYSICAL SPECIFICATIONS

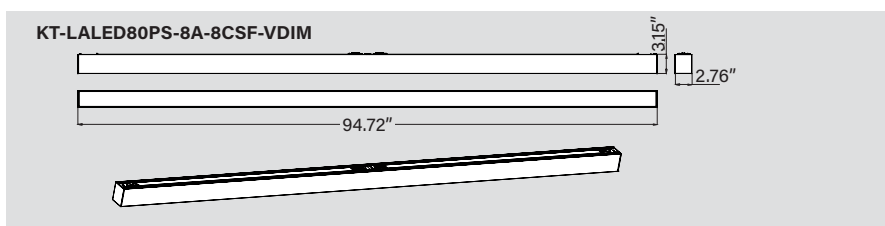
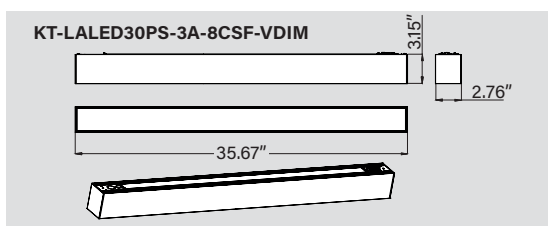
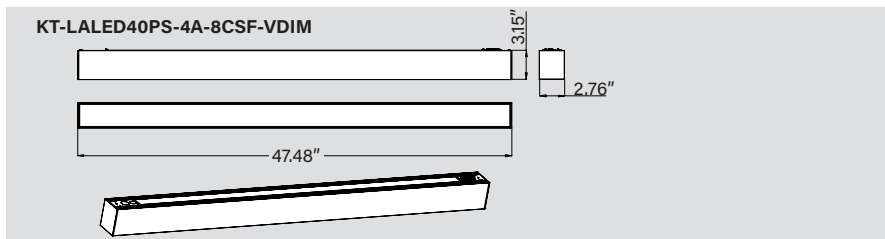
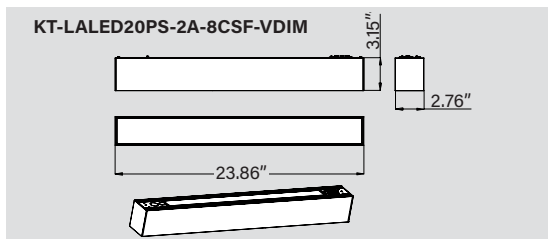

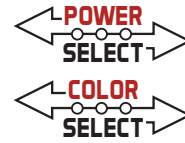

# KT-LALEDXXPS-YA-8CSF-VDIM-X

## LED LINEAR PENDANT FIXTURE

**PENDANT MOUNT CORE INSTALLATION ACCESSORIES** (sold separately)

CATALOG NUMBER	DESCRIPTION	UPC	EASY CODE
<b>ROUND CANOPY KITS</b>			
KT-LALED-5CC-1-F-KIT	Canopy Cover Feed Kit, J-Box Mount   5" Circular   White. Includes (1) 15' aircraft cable with 2 piece cable coupler, (1) 5" power feed circular canopy, (1) Crossbar w/ 1/4-20 screw, (1) 18/5 SJT sized strain relief, (5) cable ties, (NO POWER CORD INCLUDED)	843654104362	NMY-61
KT-LALED-5CC-1-F-KIT-B	Canopy Cover Feed Kit, J-Box Mount   5" Circular   Black. Includes (1) 15' aircraft cable with 2 piece cable coupler, (1) 5" power feed circular canopy, (1) Crossbar w/ 1/4-20 screw, (1) 18/5 SJT sized strain relief, (5) cable ties, (NO POWER CORD INCLUDED)	843654161563	FYY-15
KT-LALED-5CC-1-NF-KIT	Canopy Cover Non-Feed Kit, J-Box / Stud Mount   5" Circular   White. Includes (1) 15' aircraft cable with 2 piece cable coupler, (1) 5" non-feed circular canopy, (1) Crossbar w/ 1/4-20 screw	843654104461	TFG-31
KT-LALED-5CC-1-NF-KIT-B	Canopy Cover Non-Feed Kit, J-Box / Stud Mount   5" Circular   Black. Includes (1) 15' aircraft cable with 2 piece cable coupler, (1) 5" non-feed circular canopy, (1) Crossbar w/ 1/4-20 screw	843654161570	BSI-54
KT-LALED-2CC-1-NF-KIT	Canopy Cover Non-Feed Kit, Drywall / Stud Mount   2" Circular   White. Includes (1) 15' aircraft cable with cable coupler, (1) 2" non-feed circular canopy, (1) 1/4-20 Toggle Bolt Assembly, (1) 1/4-20 Lag Screw	843654104546	RZF-29
KT-LALED-2CC-1-NF-KIT-B	Canopy Cover Non-Feed Kit, Drywall / Stud Mount   2" Circular   Black. Includes (1) 15' aircraft cable with cable coupler, (1) 2" non-feed circular canopy, (1) 1/4-20 Toggle Bolt Assembly, (1) 1/4-20 Lag Screw	843654161587	YCO-17
KT-LALED-2CC-2-NF-KIT	Canopy Cover Non-Feed Kit, T-Bar Mount   2" Circular   White. Includes (1) 15' aircraft cable with 2 piece cable coupler, (1) 2" non-feed circular canopy, (1) Drop Ceiling Clip / Stud	843654104553	UOM-12
KT-LALED-2CC-2-NF-KIT-B	Canopy Cover Non-Feed Kit, T-Bar Mount   2" Circular   Black. Includes (1) 15' aircraft cable with 2 piece cable coupler, (1) 2" non-feed circular canopy, (1) Drop Ceiling Clip / Stud	843654161594	LQM-47
KT-LALED-5CC-2-NF-KIT	Canopy Cover Non-Feed Kit, T-Bar Mount   5" Circular   White. Includes (1) 15' aircraft cable with 2 piece cable coupler, (1) 5" non-feed circular canopy, (1) Drop Ceiling Clip / Stud	843654104560	YCM-01
KT-LALED-5CC-2-NF-KIT-B	Canopy Cover Non-Feed Kit, T-Bar Mount   5" Circular   Black. Includes (1) 15' aircraft cable with 2 piece cable coupler, (1) 5" non-feed circular canopy, (1) Drop Ceiling Clip / Stud	843654161600	CMN-24
KT-LALED-2CC-3-NF-KIT	Canopy Cover Non-Feed Kit, Masonry Mount   2" Circular   White. Includes (1) 15' aircraft cable with 2 piece cable coupler, (1) 2" non-feed circular canopy, (1) 1/4-20 Stud (LAG SHIELD NOT INCLUDED)	843654104577	DSO-60
KT-LALED-2CC-3-NF-KIT-B	Canopy Cover Non-Feed Kit, Masonry Mount   2" Circular   Black. Includes (1) 15' aircraft cable with 2 piece cable coupler, (1) 2" non-feed circular canopy, (1) 1/4-20 Stud (LAG SHIELD NOT INCLUDED)	843654161617	GWC-30

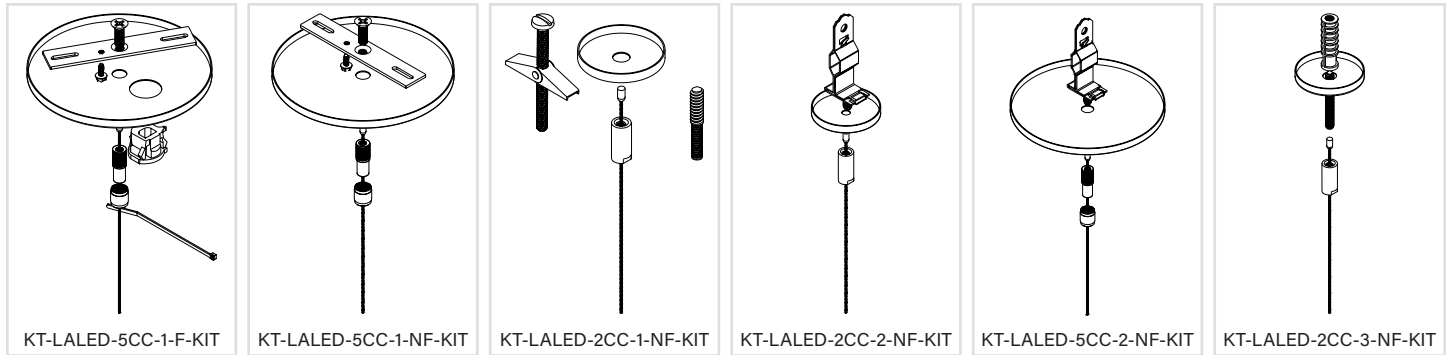

(Core Installation Accessories continued on next page)

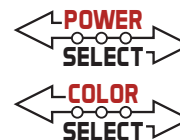

# KT-LALEDXXPS-YA-8CSF-VDIM-X

## LED LINEAR PENDANT FIXTURE

### PENDANT MOUNT CORE INSTALLATION ACCESSORIES (continued)

CATALOG NUMBER	DESCRIPTION	UPC	EASY CODE
<b>SQUARE CANOPY KITS</b>			
KT-LALED-5SC-1-F-KIT	Canopy Cover Feed Kit, J-Box Mount   5" Square   White. Includes (1) 15' aircraft cable with 2 piece cable coupler, (1) 5" power feed square canopy, (1) Crossbar w/ 1/4-20 screw, (1) 18/5 SJT sized strain relief, (5) cable ties, (NO POWER CORD INCLUDED)	843654104584	KVV-92
KT-LALED-5SC-1-F-KIT-B	Canopy Cover Feed Kit, J-Box Mount   5" Square   Black. Includes (1) 15' aircraft cable with 2 piece cable coupler, (1) 5" power feed square canopy, (1) Crossbar w/ 1/4-20 screw, (1) 18/5 SJT sized strain relief, (5) cable ties, (NO POWER CORD INCLUDED)	843654161624	GPH-64
KT-LALED-5SC-1-NF-KIT	Canopy Cover Non-Feed Kit, J-Box / Stud Mount   5" Square   White. Includes (1) 15' aircraft cable with 2 piece cable coupler, (1) 5" non-feed square canopy, (1) Crossbar w/ 1/4-20 screw	843654104591	ZTR-83
KT-LALED-5SC-1-NF-KIT-B	Canopy Cover Non-Feed Kit, J-Box / Stud Mount   5" Square   Black. Includes (1) 15' aircraft cable with 2 piece cable coupler, (1) 5" non-feed square canopy, (1) Crossbar w/ 1/4-20 screw	843654161631	GBV-15
KT-LALED-2SC-1-NF-KIT	Canopy Cover Non-Feed Kit, Drywall / Stud Mount   2" Square   White. Includes (1) 15' aircraft cable with 2 piece cable coupler, (1) 2" non-feed square canopy, (1) 1/4-20 Toggle Bolt Assembly, (1) 1/4-20 Lag Screw	843654104607	NMB-51
KT-LALED-2SC-1-NF-KIT-B	Canopy Cover Non-Feed Kit, Drywall / Stud Mount   2" Square   Black. Includes (1) 15' aircraft cable with 2 piece cable coupler, (1) 2" non-feed square canopy, (1) 1/4-20 Toggle Bolt Assembly, (1) 1/4-20 Lag Screw	843654161648	EKF-16
KT-LALED-2SC-2-NF-KIT	Canopy Cover Non-Feed Kit, T-Bar Mount   2" Square   White. Includes (1) 15' aircraft cable with 2 piece cable coupler, (1) 2" non-feed square canopy, (1) Drop Ceiling Clip / Stud	843654104683	YJL-51
KT-LALED-2SC-2-NF-KIT-B	Canopy Cover Non-Feed Kit, T-Bar Mount   2" Square   Black. Includes (1) 15' aircraft cable with 2 piece cable coupler, (1) 2" non-feed square canopy, (1) Drop Ceiling Clip / Stud	843654161655	TOK-32
KT-LALED-5SC-2-NF-KIT	Canopy Cover Non-Feed Kit, T-Bar Mount   5" Square   White. Includes (1) 15' aircraft cable with 2 piece cable coupler, (1) 5" non-feed square canopy, (1) Drop Ceiling Clip / Stud	843654104874	HZZ-53
KT-LALED-5SC-2-NF-KIT-B	Canopy Cover Non-Feed Kit, T-Bar Mount   5" Square   Black. Includes (1) 15' aircraft cable with 2 piece cable coupler, (1) 5" non-feed square canopy, (1) Drop Ceiling Clip / Stud	843654161662	VSD-51
KT-LALED-2SC-3-NF-KIT	Canopy Cover Non-Feed Kit, Masonry Mount   2" Square   White. Includes (1) 15' aircraft cable with 2 piece cable coupler, (1) 2" non-feed square canopy, (1) 1/4-20 Stud (LAG SHIELD NOT INCLUDED)	843654105055	AHB-20
KT-LALED-2SC-3-NF-KIT-B	Canopy Cover Non-Feed Kit, Masonry Mount   2" Square   Black. Includes (1) 15' aircraft cable with 2 piece cable coupler, (1) 2" non-feed square canopy, (1) 1/4-20 Stud (LAG SHIELD NOT INCLUDED)	843654161679	NBH-45

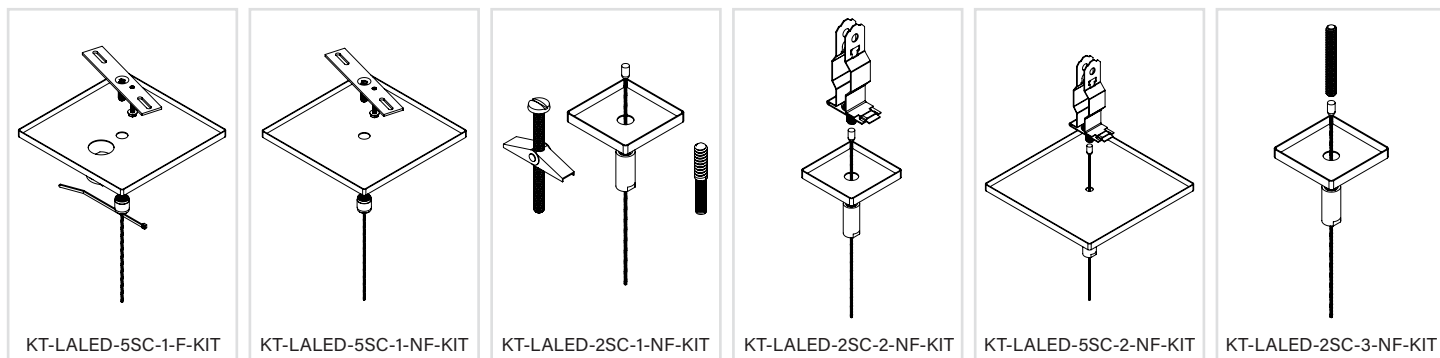

(Core Installation Accessories continued on next page)

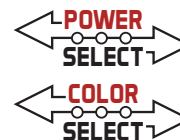

# KT-LALEDXXPS-YA-8CSF-VDIM-X

## LED LINEAR PENDANT FIXTURE

### PENDANT MOUNT CORE INSTALLATION ACCESSORIES (continued)

CATALOG NUMBER	DESCRIPTION	UPC	EASY CODE
<b>J-BOX</b>			
KT-JBOX-4TB	4" Octagon Box / T-Bar Box. (3.5" across flats.) Includes punchouts to slide over T-Bar Grid.	843654105062	IRG-22

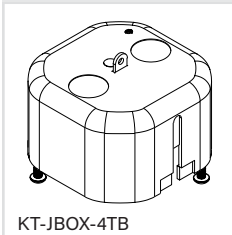

KT-JBOX-4TB

CATALOG NUMBER	DESCRIPTION	UPC	EASY CODE
<b>LENS</b>			
KT-LALED-A-32S-LENS-KIT	Monolithic Lens for KT-LALED fixtures. 32 ft Long Role. Cut to Desired Length in field	843654156873	WJF-44

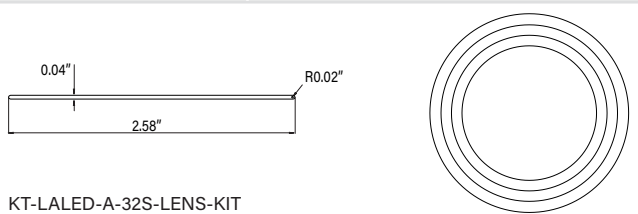

KT-LALED-A-32S-LENS-KIT

CATALOG NUMBER	DESCRIPTION	UPC	EASY CODE
<b>CORD AND WIRE HARNESS</b>			
KT-CS-NP-10-18/5-W /LA*	10' Input Power Cord, 18/5, 300V SJT   White   Includes power quick connects and strain relief optimized for KT-LALED fixtures	843654156880	STY-97
KT-CS-NP-10-18/5-B /LA	10' Input Power Cord, 18/5, 300V SJT   Black   Includes power quick connects and strain relief optimized for KT-LALED fixtures	843654161457	GOL-44
KT-CS-NP-10-18/6-W /LA	10' Input Power Cord, 18/6, 300V SJT   White   Includes power quick connects and strain relief optimized for KT-LALED fixtures	843654159164	PNQ-23
KT-CS-NP-10-18/6-B /LA	10' Input Power Cord, 18/6, 300V SJT   Black   Includes power quick connects and strain relief optimized for KT-LALED fixtures	843654159157	GXA-52
KT-LALED-WH-MD-KIT	Wire Harness Kit for Multidirectional Power feed. Used in conjunction with an input power cord, when the feed location is in center of run.	843654158532	DLH-96
KT-CS-515P-6-18/3-W /LA	(For Samples) Cordset with Plug for Linta Fixtures. 125V NEMA 5-15P Straight Blade Plug. 6ft long SJTW cable. 18/3 wire	843654159171	TBX-57

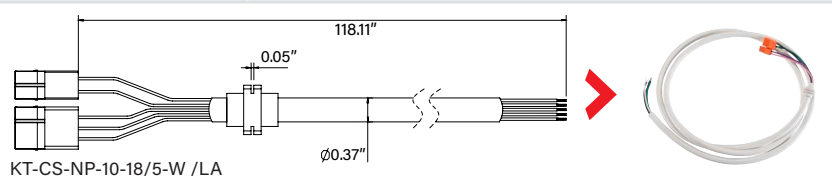

KT-CS-NP-10-18/5-W /LA

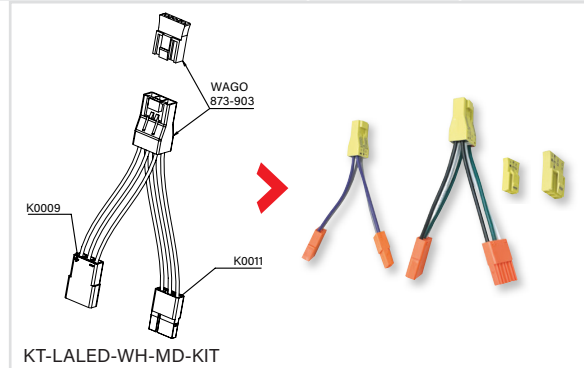

KT-LALED-WH-MD-KIT

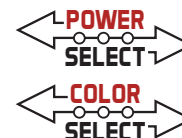

# KT-LALEDXXPS-YA-8CSF-VDIM-X

## LED LINEAR PENDANT FIXTURE

### ALTERNATE MOUNTING ACCESSORIES (SOLD SEPARATELY)

CATALOG NUMBER	DESCRIPTION	UPC	EASY CODE
<b>WALL MOUNT KITS AND ACCESSORIES</b>			
KT-LALED-2A-WM-KIT	Wall Mounting Kit for 2' Fixtures. Includes standard length 5 wire wiring harness. White	843654157894	NAJ-17
KT-LALED-2A-WM-KIT-B	Wall Mounting Kit for 2' Fixtures. Includes standard length 5 wire wiring harness. Black	843654161525	JQS-70
KT-LALED-3A-WM-KIT	Wall Mounting Kit for 3' Fixtures. Includes standard length 5 wire wiring harness. White	843654157900	NOO-02
KT-LALED-3A-WM-KIT-B	Wall Mounting Kit for 3' Fixtures. Includes standard length 5 wire wiring harness. Black	843654161532	RFO-87
KT-LALED-4A-WM-KIT	Wall Mounting Kit for 4' Fixtures. Includes standard length 5 wire wiring harness. White	843654156859	ARZ-81
KT-LALED-4A-WM-KIT-B	Wall Mounting Kit for 4' Fixtures. Includes standard length 5 wire wiring harness. Black	843654161549	VOV-66
KT-LALED-8A-WM-KIT	Wall Mounting Kit for 8' Fixtures. Includes standard length 5 wire wiring harness. White	843654156866	EJW-29
KT-LALED-8A-WM-KIT-B	Wall Mounting Kit for 8' Fixtures. Includes standard length 5 wire wiring harness. Black	843654161556	PLV-77
KT-LALED-A-LBR-WM	Linking Bracket for Wall Mount End to End daisychain connections. (Optional)	843654158464	WRU-16
KT-LALED-WH-WM-20-KIT	Extended Length Wire Harness for wall mount kit, 20', 5 wire. For use with daisy chain wall mount installations with a center power feed location	843654158549	XGL-51
KT-LALED-WH-WM-20EM-KIT	Extended Length Wire Harness for wall mount kit, 20', 6 wire. For use with daisy chain wall mount installations with a center power feed location for Emergency Backup Needs (extra conductor for switch leg)	843654158556	SPM-05

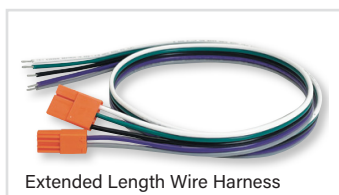

CATALOG NUMBER	DESCRIPTION	UPC	EASY CODE
<b>SURFACE MOUNT KITS AND ACCESSORIES</b>			
KT-LALED-2A-SM-KIT	Surface Mounting Kit for 2' Fixtures. White	843654157870	PZA-14
KT-LALED-2A-SM-KIT-B	Surface Mounting Kit for 2' Fixtures. Black	843654161488	VCX-67
KT-LALED-3A-SM-KIT	Surface Mounting Kit for 3' Fixtures. White	843654157887	UON-33
KT-LALED-3A-SM-KIT-B	Surface Mounting Kit for 3' Fixtures. Black	843654161495	OKS-15
KT-LALED-4A-SM-KIT	Surface Mounting Kit for 4' Fixtures. White	843654156811	UDG-40
KT-LALED-4A-SM-KIT-B	Surface Mounting Kit for 4' Fixtures. Black	843654161501	UWO-08
KT-LALED-8A-SM-KIT	Surface Mounting Kit for 8' Fixtures. White	843654156828	YUT-17
KT-LALED-8A-SM-KIT-B	Surface Mounting Kit for 8' Fixtures. Black	843654161518	QOE-60



CATALOG NUMBER	DESCRIPTION	UPC	EASY CODE
<b>RECESSED MOUNT KITS AND ACCESSORIES</b>			
KT-LALED-2A-RM-KIT	Recessed Mounting Kit for 2' Fixtures in Drywall Ceilings	843654158495	NVI-25
KT-LALED-3A-RM-KIT	Recessed Mounting Kit for 3' Fixtures in Drywall Ceilings	843654158501	SYQ-66
KT-LALED-4A-RM-KIT	Recessed Mounting Kit for 4' Fixtures in Drywall Ceilings	843654156835	ZXE-03
KT-LALED-8A-RM-KIT	Recessed Mounting Kit for 8' Fixtures in Drywall Ceilings	843654156842	GSI-69

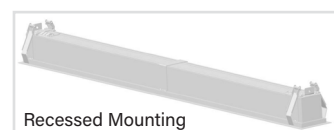

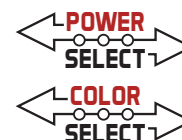

# KT-LALEDXXPS-YA-8CSF-VDIM-X

## LED LINEAR PENDANT FIXTURE

### ACCESSORIES

#### SENSORS

Factory-Installable OR Field-Installable (field-installable purchased separately)

✓	SUFFIX*	CATALOG NUMBER	DESCRIPTION	UPC	EASY CODE
	/FC2	KTSL-FC2-12V-SM-PIR	Bluetooth mesh wireless low voltage individual fixture controller for SmartLoop system with integrated daylight and PIR motion sensors, 12V, 0-10V Dimming	843654135236	TCM-01



Field-Installable / Field-Use ONLY (purchased separately)

CATALOG NUMBER	DESCRIPTION	UPC	EASY CODE
KT-LALED-A-EC-SL	End Cap for Smart Loop Wireless Control Sensor	843654156767	WMK-35

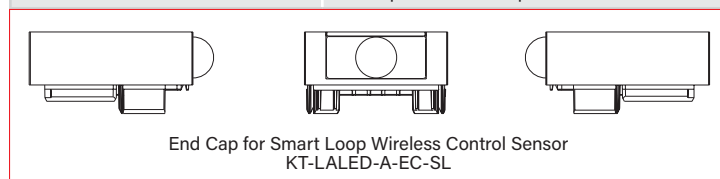

\* FOR FACTORY INSTALLATION OF ACCESSORY, ADD SUFFIX TO FIXTURE PART NUMBER (SEE ORDERING EXAMPLES AND INSTRUCTIONS ON LAST PAGE OF SPEC SHEET).

\*\*Factory installation of Sensor will automatically include any relevant mounting bracket

\*\*\*Sensor only compatible with pendant mount hanging installation. Not for use with Wall, Surface, or recessed mount applications

#### EMERGENCY BACKUP

Factory-Installable OR Field-Installable (field-installable purchased separately)

✓	SUFFIX*	CATALOG NUMBER	DESCRIPTION	UPC	EASY CODE
	/EM5†	KT-EMRG-LED-5C-500-SEN	LED Emergency Back-Up, One Piece Slim 5W Constant Wattage Design, Approx 500 Lumens. 90 Min Operation, 120-277V Input, CEC T20 Compliant. Includes Test Switch, and Wiring Accessories	843654128276	CPO-29



\* FOR FACTORY INSTALLATION OF ACCESSORY, ADD SUFFIX TO FIXTURE PART NUMBER (SEE ORDERING EXAMPLES AND INSTRUCTIONS ON LAST PAGE OF SPEC SHEET)).

\*\*Factory installation of Emergency Backup will automatically include any relevant accessories to accommodate the installation

\*\*\*Emergency Backup is NOT compatible with 2' and 3' fixtures. 4' and 8' only.

#### MOUNTS AND BRACKETS

Field-Installable / Field-Use ONLY (purchased separately)

✓	SUFFIX*	CATALOG NUMBER	DESCRIPTION	UPC	EASY CODE
		KT-LALED-A-EC-EM	End Cap for Emergency backup test button	843654156774	DGB-72
		KT-LALED-CANOPY-1-KIT	Pair of 5" circular canopy covers, with included hardware to install (1) fixture. One Power Feed one Non-Power Feed. For use with standard J-Box / Stud mount installations. Compatible with aircraft cable hardware included with each fixture	843654156798	ZAW-46
		KT-LALED-CABLE-1-KIT	Standard Cable Hanging Kit, suitable for Hard Ceiling or Loop Over Hanging Installations (Replacement for what is included in each fixture)	843654156781	TUV-08
		KT-LALED-A-LBR	Linking Bracket for End to End Linear Connections. (Replacement for what is included in each fixture)	843654156804	IAI-11

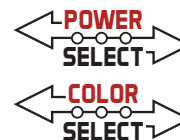

# KT-LALEDXXPS-YA-8CSF-VDIM-X

## LED LINEAR PENDANT FIXTURE

### ORDERING INFORMATION

CATALOG NUMBER	PACK QUANTITY	WEIGHT	UPC	EASY CODE
KT-LALED20PS-2A-8CSF-VDIM	1	4.5 lbs	843654156729	OLD-23
KT-LALED20PS-2A-8CSF-VDIM-B			843654161389	OIG-02
KT-LALED30PS-3A-8CSF-VDIM		5.7 lbs	843654156736	OTA-53
KT-LALED30PS-3A-8CSF-VDIM-B			843654161396	UHH-97
KT-LALED40PS-4A-8CSF-VDIM		7.0 lbs	843654156743	TBO-54
KT-LALED40PS-4A-8CSF-VDIM-B			843654161402	HGE-33
KT-LALED80PS-8A-8CSF-VDIM		13.0 lbs	843654156750	ULO-92
KT-LALED80PS-8A-8CSF-VDIM-B			843654161419	KZB-70

### CATALOG NUMBER BREAKDOWN

# KT-LALEDXXPS-YA-8CSF-VDIM-X

- 1** Keystone Technologies
- 2** Linear Architectural LED Fixture
- 3** Wattage
- 4** Power Select
- 5** Nominal Length
- 6** Series/Form Factor
- 7** 80 CRI
- 8** Color Select
- 9** Color Select Designation
- 10** 0-10V Dimming
- 11** Housing Color\*

3 Wattage	
20	20W
30	30W
40	40W
80	80W

5 Nominal Length	
2	2'
3	3'
4	4'
8	8'

9 Color Select Designation	
F	2700, 3000, 3500, 4000, 5000K

11 Housing Color*	
	White
B	Black
S	Silver (Special Order Only, Extended Lead Times Apply)



\*White and Black Standard. Other finishes available, lead times apply. Contact Keystone sales rep for details/options on colors other than White and Black.

### ORDERING EXAMPLES

FIXTURE WITH TWO FACTORY-INSTALLED ACCESSORIES\*

**KT-LALEDXXPS-YA-8CSF-VDIM/FC2/EM5**

FIXTURE WITH SINGLE FACTORY-INSTALLED ACCESSORY

**KT-LALEDXXPS-YA-8CSF-VDIM/FC2**

FIXTURE WITH NO FACTORY-INSTALLED ACCESSORIES

**KT-LALEDXXPS-YA-8CSF-VDIM**

KEYSTONE FIXTURE	
CATALOG NUMBER	
KT-LALEDXXPS-YA-8CSF-VDIM	

SENSORS AND CONTROLLERS	
✓ SUFFIX	CATALOG NUMBER
/FC2	KTSL-FC2-12V-SM-PIR

EMERGENCY BACKUP	
✓ SUFFIX	CATALOG NUMBER
/EM5	KT-EMRG-LED-5C-500-SEN

\*When ordering more than one factory-installed accessory, use multiple suffixes as shown in the ordering examples above.  
**Note:** All accessories can also be ordered separately for field installation using just their regular Catalog Number, UPC, or Easy Code.