



# KT-LED82P-V-8CSI-D

## 2-PIN LED LAMP



**DESCRIPTION**

8.5W 2-Pin LED Lamp | Color Select 2700K, 4000K, 5000K |  $\geq 82$  CRI

<b>LAMP TYPE:</b> Compact
<b>BULB TYPE:</b> 2-Pin LED
<b>BASE TYPE:</b> G24d
<b>WATTAGE:</b> 8.5W
<b>SELECTABLE COLOR TEMPERATURE:</b> 2700K, 4000K, 5000K
<b>COLOR RENDERING INDEX (CRI):</b> $\geq 82$
<b>WARRANTY:</b> 5 Years



**PRODUCT FEATURES**

- Operating temperature: -20°C/-4°F to 45°C/113°F
- Instant startup
- Environmentally friendly: no mercury used
- Frosted lens eliminates pixelation
- Suitable for use in dry and damp locations
- UL Classified
- Rotatable 270°
- G24D 2-pin can be used in G24Q 4-pin applications for ballast bypass
- Save 50% on energy consumption compared to typical CFL bulbs
- Extend useful life four times (50,000 hours)
- Simplifies installation without the need for an external driver or ballast

**OPERATING SPECIFICATIONS**

**ELECTRICAL CHARACTERISTICS**

Input Voltage	Lamp Wattage	Power Factor	System Wattage
120-277V	8.5W	>0.9	8.5W

**PHOTOMETRIC CHARACTERISTICS**

Color Temperature (CCT)	2700K*	4000K	5000K
Luminous Flux	1000	1150	1150
Color Rendering Index (CRI)	$\geq 82$	$\geq 82$	$\geq 82$
Bare Lamp Efficacy	118	135	135

\*Preset to 2700K

**RATED LIFE**

L70 (Hours)	50,000
-------------	--------

**POLAR CANDELA DISTRIBUTION**

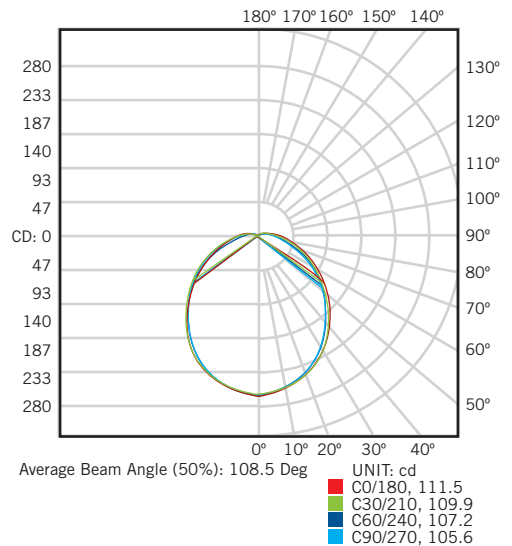

# KT-LED82P-V-8CSI-D

## 2-PIN LED LAMP

### WIRING

#### BYPASS MAGNETIC BALLAST WITH 1 LAMP

**BEFORE**

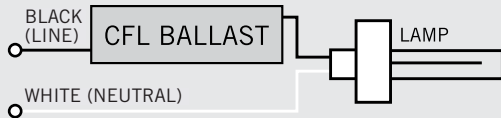

**AFTER**

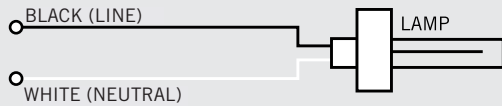

#### BYPASS ELECTRONIC BALLAST WITH 1 LAMP

**BEFORE**

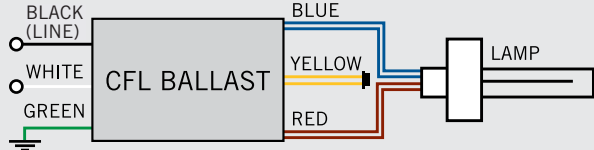

**AFTER**

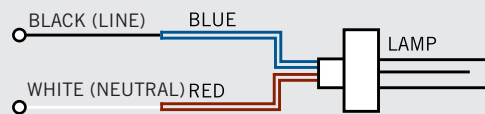

#### BYPASS MAGNETIC BALLAST WITH 2 LAMPS

**BEFORE**

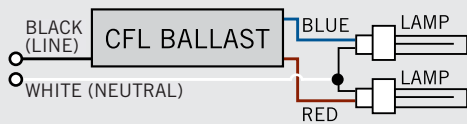

**AFTER**

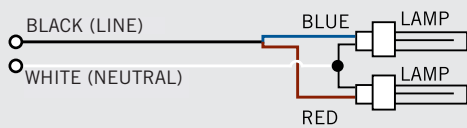

#### BYPASS ELECTRONIC BALLAST WITH 2 LAMPS

**BEFORE**

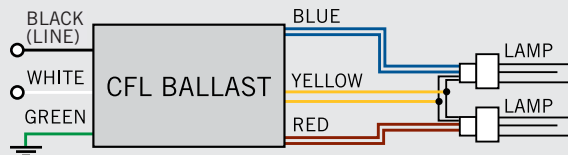

**AFTER**

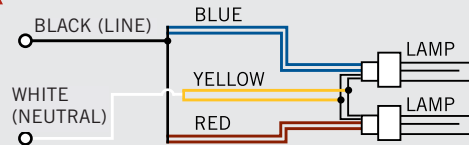

### PHYSICAL CHARACTERISTICS

#### LAMP DIMENSIONS

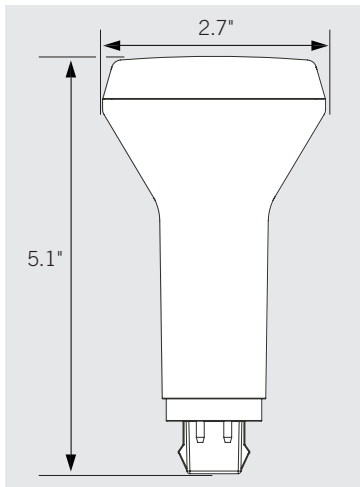



# KT-LED82P-V-8CSI-D

2-PIN LED LAMP

### ORDERING INFORMATION

ORDER CODE	PACK QTY.	UPC	EASY CODE
KT-LED82P-V-8CSI-D	24	843654137704	RUQ-83

### CATALOG NUMBER BREAKDOWN

# KT-LED82P-V-8CSI-D

1 2 3 4 5 6 7 8 9

- 1 Keystone Technologies
- 2 LED Lamp
- 3 Wattage
- 4 2-Pin Lamp Type
- 5 Vertical Orientation
- 6 80 CRI
- 7 Color Select
- 8 Color Select Designation
- 9 Direct Drive Series

#### 8 Color Select Designation

I 2700K, 4000K, 5000K