

KT-LEDXXPSWD-XX-9CSF-DIM-X

LED WAFER DOWNLIGHT RETROFIT TRIM

DESCRIPTION

4" or 6" Wafer Downlight Retrofit Trim |
 Power Select | Color Select | Quick-Disconnect
 E26 Base | White or Black

APPLICATION

Ideal for residential, hospitality, retail, office, and
 other retrofit and remodel construction applications

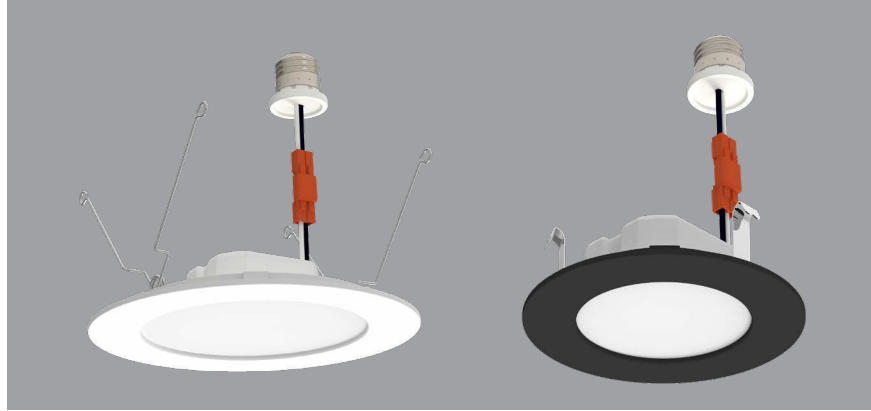

PRODUCT FEATURES

- Keystone Power Select technology (see Performance Specifications for details)
- Keystone Color Select technology (2700/3000/3500/4000/5000K)
- Includes quick-disconnect E26 base adaptor for easy, screw-in install
- Improved aesthetics vs legacy trims
- Ideal for retrofit and remodel applications
- Various styles and colors available
- Diffused lens for visual comfort and reduced glare
- Smooth, uniform dimming
- Suitable for use in wet locations
- Suitable for use in 4" and 6" recessed cans
- PF > 0.9
- Operating temperature range: -4°F/-20°C to 95°F/35°C
- UL 1598C Retrofit Kit
- T20/T24/JA8 compliant
- Complies with Part 15 of FCC

PRODUCT IMAGES

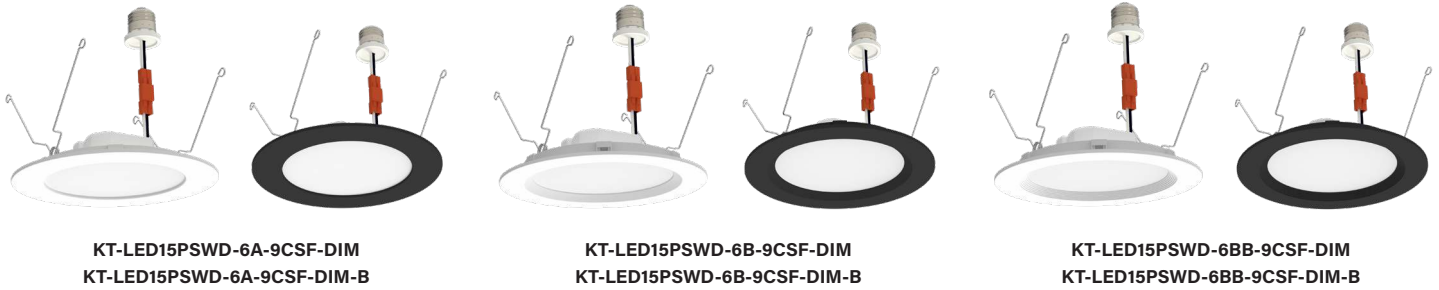



KT-LEDXXPSWD-XX-9CSF-DIM-X

LED WAFER DOWNLIGHT RETROFIT TRIM

PERFORMANCE SPECIFICATIONS - WHITE TRIM COLOR

Catalog Number	Size	Style	Selectable Wattage	Selectable CCT *	Lumens	Efficacy	Input Voltage	Dimmable	CRI	Rated Life
KT-LED15PSWD-6A-9CSF-DIM	6"	Slim	15W	2700K	1310	87 lm/W	120V	TRIAC	> 90	50,000 hrs
				3000K	1340	89 lm/W				
				3500K	1380	92 lm/W				
				4000K	1370	91 lm/W				
				5000K	1320	88 lm/W				
			13W	2700K	1160	89 lm/W				
				3000K	1190	92 lm/W				
				3500K	1220	94 lm/W				
				4000K	1210	93 lm/W				
				5000K	1170	90 lm/W				
			11W	2700K	960	87 lm/W				
				3000K	980	89 lm/W				
				3500K	1000	91 lm/W				
				4000K	990	90 lm/W				
				5000K	970	88 lm/W				
KT-LED15PSWD-6B-9CSF-DIM	6"	Regressed Smooth	15W	2700K	1310	87 lm/W	120V	TRIAC	> 90	50,000 hrs
				3000K	1340	89 lm/W				
				3500K	1380	92 lm/W				
				4000K	1370	91 lm/W				
				5000K	1320	88 lm/W				
			13W	2700K	1160	89 lm/W				
				3000K	1190	92 lm/W				
				3500K	1220	94 lm/W				
				4000K	1210	93 lm/W				
				5000K	1170	90 lm/W				
			11W	2700K	960	87 lm/W				
				3000K	980	89 lm/W				
				3500K	1000	91 lm/W				
				4000K	990	90 lm/W				
				5000K	970	88 lm/W				
KT-LED15PSWD-6BB-9CSF-DIM	6"	Regressed Baffled	15W	2700K	1300	87 lm/W	120V	TRIAC	> 90	50,000 hrs
				3000K	1340	89 lm/W				
				3500K	1370	91 lm/W				
				4000K	1360	91 lm/W				
				5000K	1310	87 lm/W				
			13W	2700K	1150	88 lm/W				
				3000K	1180	91 lm/W				
				3500K	1210	93 lm/W				
				4000K	1200	92 lm/W				
				5000K	1160	89 lm/W				
			11W	2700K	950	86 lm/W				
				3000K	970	88 lm/W				
				3500K	990	90 lm/W				
				4000K	980	89 lm/W				
				5000K	960	87 lm/W				

*Preset to lowest CCT: 2700K
 Color Uniformity: CCT (Correlated Color Temperature) range as per guidelines outlined in ANSI C78.377-2017

(Performance Specifications continue on next page)

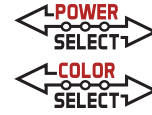

KT-LEDXXPSWD-XX-9CSF-DIM-X

LED WAFER DOWNLIGHT RETROFIT TRIM

PERFORMANCE SPECIFICATIONS - WHITE TRIM COLOR (CONTINUED)

Catalog Number	Size	Style	Selectable Wattage	Selectable CCT *	Lumens	Efficacy	Input Voltage	Dimmable	CRI	Rated Life
KT-LED10PSWD-4A-9CSF-DIM	4"	Slim	10W	2700K	840	84 lm/W	120V	TRIAC	> 90	50,000 hrs
				3000K	870	87 lm/W				
				3500K	890	89 lm/W				
				4000K	880	88 lm/W				
				5000K	850	85 lm/W				
			8W	2700K	690	86 lm/W				
				3000K	700	88 lm/W				
				3500K	720	90 lm/W				
				4000K	710	89 lm/W				
				5000K	700	88 lm/W				
			6W	2700K	530	88 lm/W				
				3000K	540	90 lm/W				
				3500K	550	92 lm/W				
				4000K	550	92 lm/W				
				5000K	540	90 lm/W				
KT-LED10PSWD-4B-9CSF-DIM	4"	Regressed Smooth	10W	2700K	840	84 lm/W	120V	TRIAC	> 90	50,000 hrs
				3000K	870	87 lm/W				
				3500K	890	89 lm/W				
				4000K	880	88 lm/W				
				5000K	850	85 lm/W				
			8W	2700K	690	86 lm/W				
				3000K	700	88 lm/W				
				3500K	720	90 lm/W				
				4000K	710	89 lm/W				
				5000K	700	88 lm/W				
			6W	2700K	530	88 lm/W				
				3000K	540	90 lm/W				
				3500K	550	92 lm/W				
				4000K	550	92 lm/W				
				5000K	540	90 lm/W				
KT-LED10PSWD-4BB-9CSF-DIM	6"	Regressed Baffled	10W	2700K	840	84 lm/W	120V	TRIAC	> 90	50,000 hrs
				3000K	870	87 lm/W				
				3500K	880	88 lm/W				
				4000K	880	88 lm/W				
				5000K	840	84 lm/W				
			8W	2700K	690	86 lm/W				
				3000K	700	88 lm/W				
				3500K	710	89 lm/W				
				4000K	700	88 lm/W				
				5000K	690	86 lm/W				
			6W	2700K	530	88 lm/W				
				3000K	540	90 lm/W				
				3500K	550	92 lm/W				
				4000K	540	90 lm/W				
				5000K	530	88 lm/W				

*Preset to lowest CCT: 2700K
 Color Uniformity: CCT (Correlated Color Temperature) range as per guidelines outlined in ANSI C78.377-2017

(Performance Specifications continue on next page)



KT-LEDXXPSWD-XX-9CSF-DIM-X

LED WAFER DOWNLIGHT RETROFIT TRIM

PERFORMANCE SPECIFICATIONS - BLACK TRIM COLOR

Catalog Number	Size	Style	Selectable Wattage	Selectable CCT *	Lumens	Efficacy	Input Voltage	Dimmable	CRI	Rated Life
KT-LED15PSWD-6A-9CSF-DIM-B	6"	Slim	15W	2700K	1200	80 lm/W	120V	TRIAC	> 90	50,000 hrs
				3000K	1260	84 lm/W				
				3500K	1330	89 lm/W				
				4000K	1340	89 lm/W				
				5000K	1320	88 lm/W				
			13W	2700K	1070	82 lm/W				
				3000K	1130	87 lm/W				
				3500K	1180	91 lm/W				
				4000K	1190	92 lm/W				
				5000K	1190	92 lm/W				
			11W	2700K	900	82 lm/W				
				3000K	940	85 lm/W				
				3500K	990	90 lm/W				
				4000K	1000	91 lm/W				
				5000K	1000	91 lm/W				
KT-LED15PSWD-6B-9CSF-DIM-B	6"	Regressed Smooth	15W	2700K	1150	77 lm/W	120V	TRIAC	> 90	50,000 hrs
				3000K	1230	82 lm/W				
				3500K	1280	85 lm/W				
				4000K	1310	87 lm/W				
				5000K	1300	87 lm/W				
			13W	2700K	1050	81 lm/W				
				3000K	1100	85 lm/W				
				3500K	1150	88 lm/W				
				4000K	1170	90 lm/W				
				5000K	1160	89 lm/W				
			11W	2700K	860	78 lm/W				
				3000K	900	82 lm/W				
				3500K	940	85 lm/W				
				4000K	960	87 lm/W				
				5000K	960	87 lm/W				
KT-LED15PSWD-6BB-9CSF-DIM-B	6"	Regressed Baffled	15W	2700K	1160	77 lm/W	120V	TRIAC	> 90	50,000 hrs
				3000K	1220	81 lm/W				
				3500K	1270	85 lm/W				
				4000K	1310	87 lm/W				
				5000K	1300	87 lm/W				
			13W	2700K	1050	81 lm/W				
				3000K	1100	85 lm/W				
				3500K	1150	88 lm/W				
				4000K	1170	90 lm/W				
				5000K	1160	89 lm/W				
			11W	2700K	860	78 lm/W				
				3000K	900	82 lm/W				
				3500K	940	85 lm/W				
				4000K	970	88 lm/W				
				5000K	970	88 lm/W				

*Preset to lowest CCT: 2700K

Color Uniformity: CCT (Correlated Color Temperature) range as per guidelines outlined in ANSI C78.377-2017

(Performance Specifications continue on next page)



KT-LEDXXPSWD-XX-9CSF-DIM-X

LED WAFER DOWNLIGHT RETROFIT TRIM

PERFORMANCE SPECIFICATIONS - BLACK TRIM COLOR (CONTINUED)

Catalog Number	Size	Style	Selectable Wattage	Selectable CCT *	Lumens	Efficacy	Input Voltage	Dimmable	CRI	Rated Life
KT-LED10PSWD-4A-9CSF-DIM-B	4"	Slim	10W	2700K	760	76 lm/W	120V	TRIAC	> 90	50,000 hrs
				3000K	800	80 lm/W				
				3500K	840	84 lm/W				
				4000K	850	85 lm/W				
				5000K	850	85 lm/W				
			8W	2700K	630	79 lm/W				
				3000K	660	83 lm/W				
				3500K	690	86 lm/W				
				4000K	700	88 lm/W				
				5000K	700	88 lm/W				
			6W	2700K	490	82 lm/W				
				3000K	510	85 lm/W				
				3500K	530	88 lm/W				
				4000K	540	90 lm/W				
				5000K	540	90 lm/W				
KT-LED10PSWD-4B-9CSF-DIM-B	4"	Regressed Smooth	10W	2700K	750	75 lm/W	120V	TRIAC	> 90	50,000 hrs
				3000K	790	79 lm/W				
				3500K	830	83 lm/W				
				4000K	840	84 lm/W				
				5000K	840	84 lm/W				
			8W	2700K	620	78 lm/W				
				3000K	650	81 lm/W				
				3500K	680	85 lm/W				
				4000K	690	86 lm/W				
				5000K	690	86 lm/W				
			6W	2700K	480	80 lm/W				
				3000K	500	83 lm/W				
				3500K	520	87 lm/W				
				4000K	530	88 lm/W				
				5000K	530	88 lm/W				
KT-LED10PSWD-4BB-9CSF-DIM-B	4"	Regressed Baffled	10W	2700K	750	75 lm/W	120V	TRIAC	> 90	50,000 hrs
				3000K	780	78 lm/W				
				3500K	830	83 lm/W				
				4000K	840	84 lm/W				
				5000K	830	83 lm/W				
			8W	2700K	610	76 lm/W				
				3000K	640	80 lm/W				
				3500K	670	84 lm/W				
				4000K	690	86 lm/W				
				5000K	690	86 lm/W				
			6W	2700K	470	78 lm/W				
				3000K	500	83 lm/W				
				3500K	520	87 lm/W				
				4000K	530	88 lm/W				
				5000K	530	88 lm/W				

*Preset to lowest CCT: 2700K

Color Uniformity: CCT (Correlated Color Temperature) range as per guidelines outlined in ANSI C78.377-2017

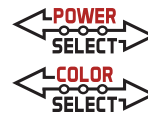

KT-LEDXXPSWD-XX-9CSF-DIM-X

LED WAFER DOWNLIGHT RETROFIT TRIM

PHOTOMETRIC SPECIFICATIONS

KT-LED15PSWD-6A-9CSF-DIM

Luminous Intensity Distribution

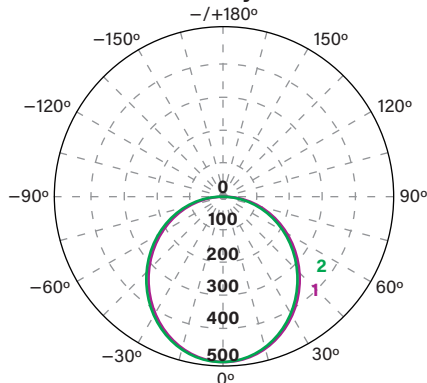

Mounting Height Distribution

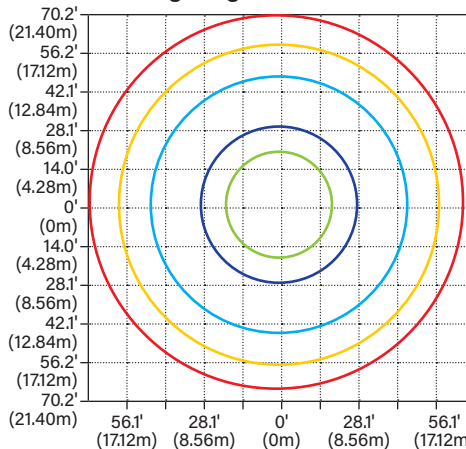

KT-LED15PSWD-6B-9CSF-DIM

Luminous Intensity Distribution

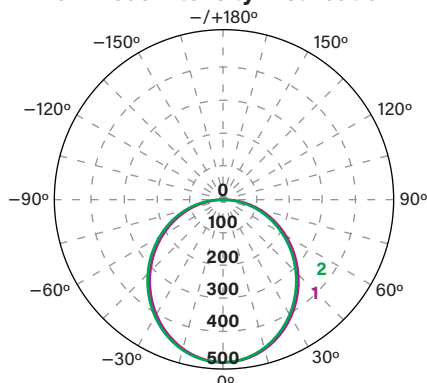

Mounting Height Distribution

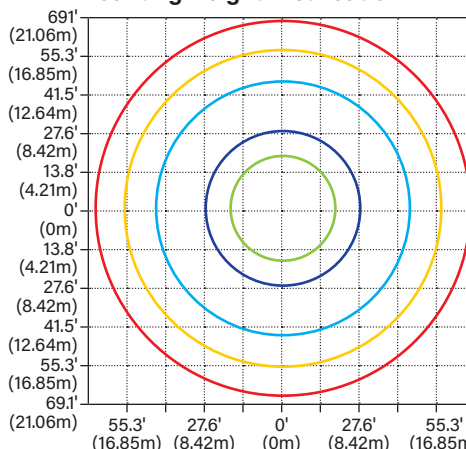

KT-LED15PSWD-6BB-9CSF-DIM

Luminous Intensity Distribution

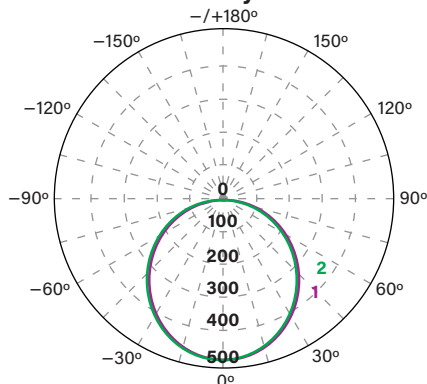

Mounting Height Distribution

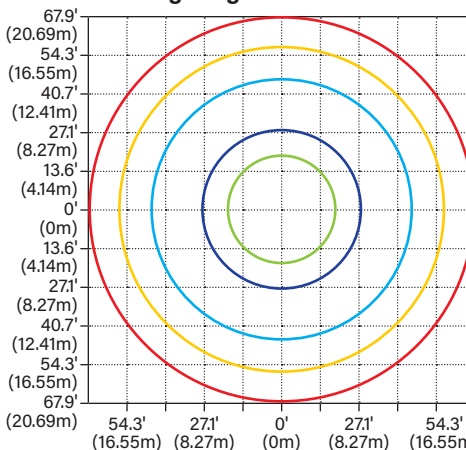

(Photometric Specifications continue on next page)

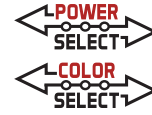

KT-LEDXXPSWD-XX-9CSF-DIM-X

LED WAFER DOWNLIGHT RETROFIT TRIM

PHOTOMETRIC SPECIFICATIONS (CONTINUED)

KT-LED10PSWD-4A-9CSF-DIM

Luminous Intensity Distribution

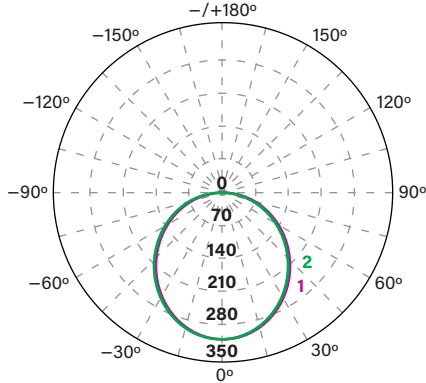

Mounting Height Distribution

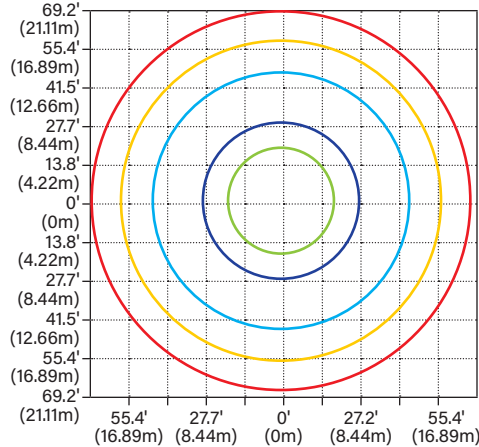

KT-LED10PSWD-4B-9CSF-DIM

Luminous Intensity Distribution

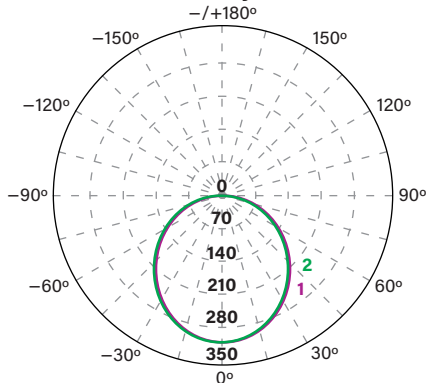

Mounting Height Distribution

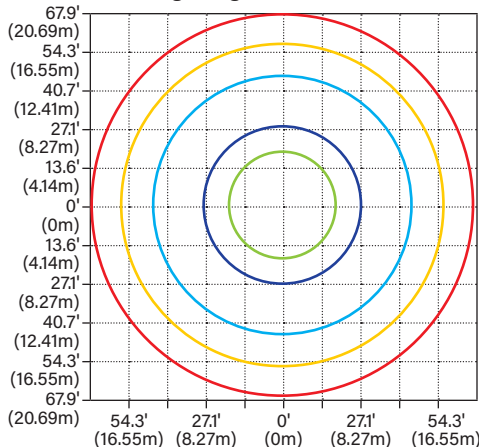

KT-LED10PSWD-4BB-9CSF-DIM

Luminous Intensity Distribution

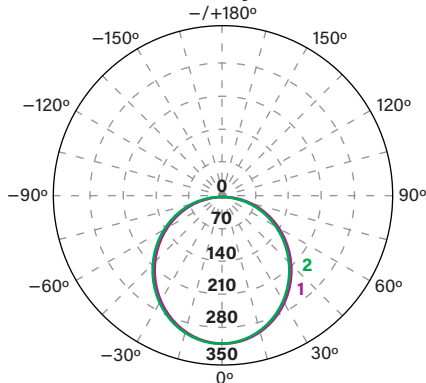

Mounting Height Distribution

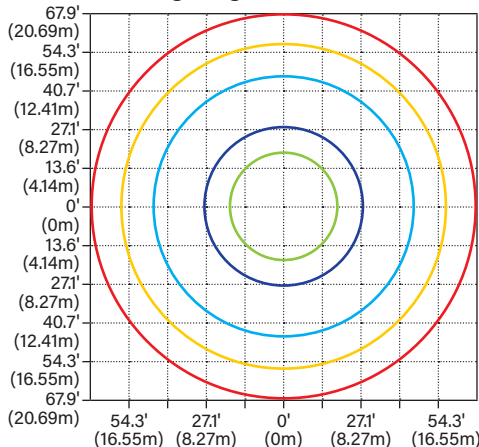

(Photometric Specifications continue on next page)



KT-LEDXXPSWD-XX-9CSF-DIM-X

LED WAFER DOWNLIGHT RETROFIT TRIM

PHOTOMETRIC SPECIFICATIONS (CONTINUED)

KT-LED15PSWD-6A-9CSF-DIM-B

Luminous Intensity Distribution

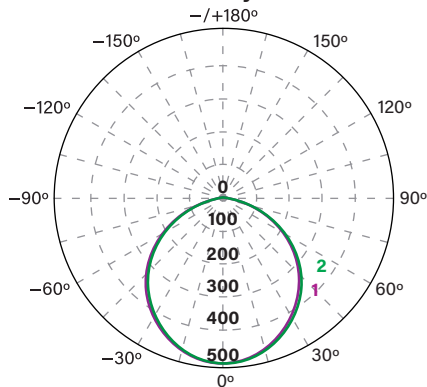

Mounting Height Distribution

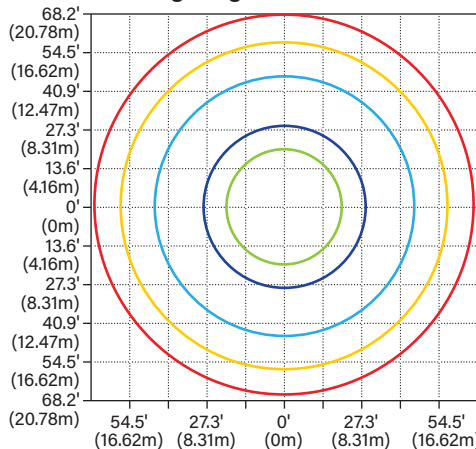

Mounting Height: **33.00' (10.0m)**

3%	0.14701x	0.01366 fc
5%	0.24501x	0.02276 fc
10%	0.49001x	0.04553 fc
30%	1.4701x	0.1366 fc
50%	2.4501x	0.2276 fc

KT-LED15PSWD-6B-9CSF-DIM-B

Luminous Intensity Distribution

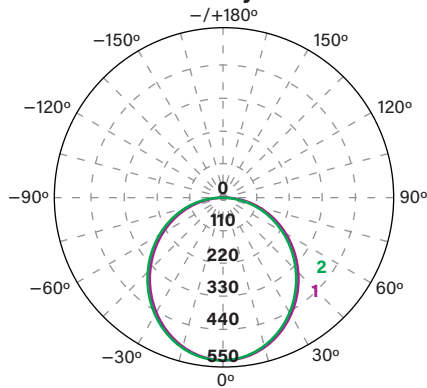

Mounting Height Distribution

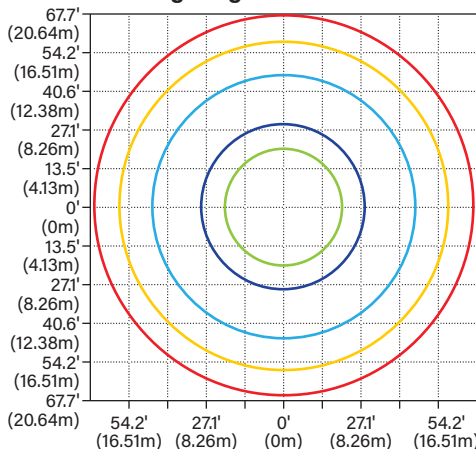

Mounting Height: **33.00' (10.0m)**

3%	0.15151x	0.01407 fc
5%	0.25251x	0.02346 fc
10%	0.50501x	0.04692 fc
30%	1.5151x	0.1407 fc
50%	2.5251x	0.2346 fc

KT-LED15PSWD-6BB-9CSF-DIM-B

Luminous Intensity Distribution

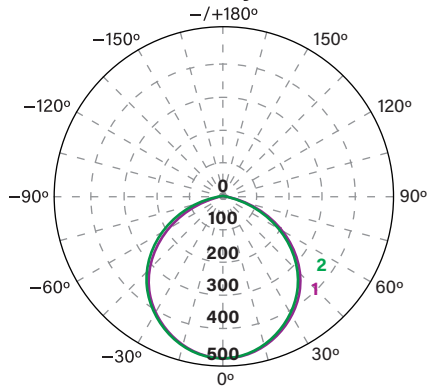

Mounting Height Distribution

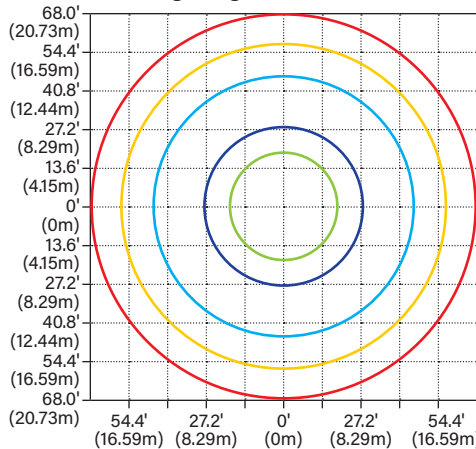

Mounting Height: **33.00' (10.0m)**

3%	0.14261x	0.01325 fc
5%	0.23761x	0.02208 fc
10%	0.47531x	0.04416 fc
30%	1.4261x	0.1325 fc
50%	2.3761x	0.2208 fc

(Photometric Specifications continue on next page)

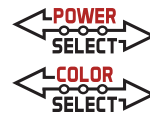

KT-LEDXXPSWD-XX-9CSF-DIM-X

LED WAFER DOWNLIGHT RETROFIT TRIM

PHOTOMETRIC SPECIFICATIONS (CONTINUED)

KT-LED10PSWD-4A-9CSF-DIM-B

Luminous Intensity Distribution

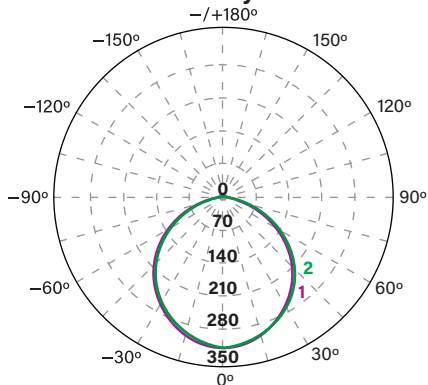

Mounting Height Distribution

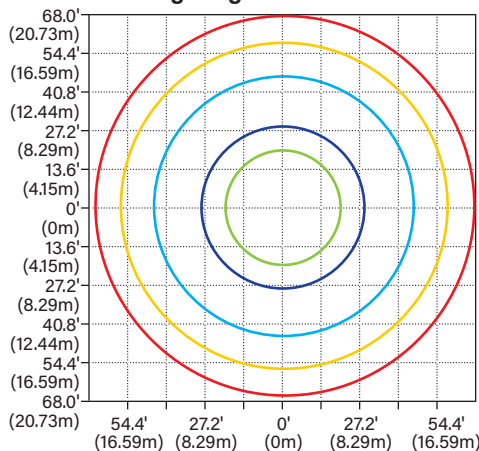

KT-LED10PSWD-4B-9CSF-DIM-B

Luminous Intensity Distribution

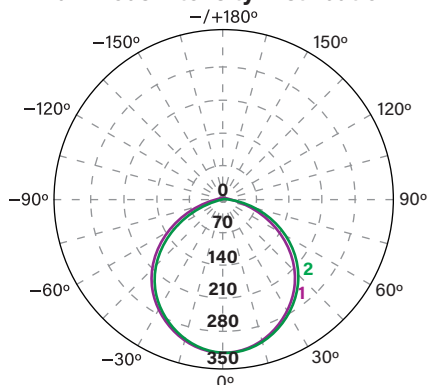

Mounting Height Distribution

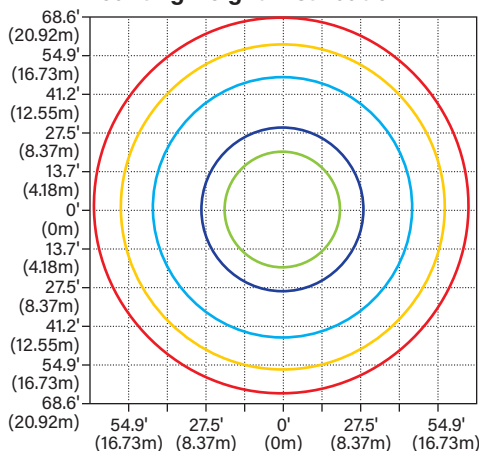

KT-LED10PSWD-4BB-9CSF-DIM-B

Luminous Intensity Distribution

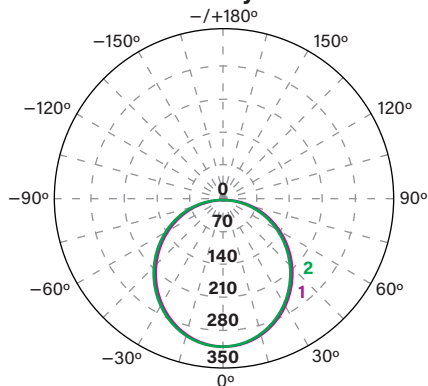

Mounting Height Distribution

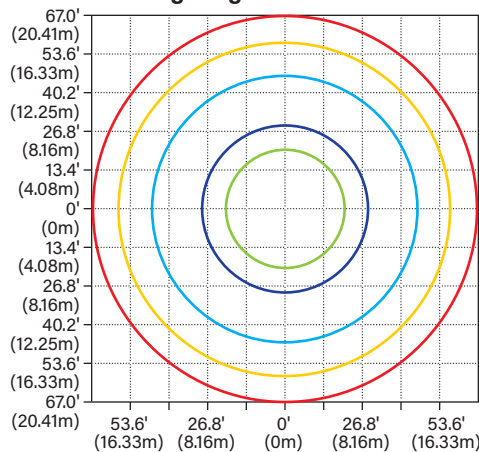

KT-LEDXXPSWD-XX-9CSF-DIM-X

LED WAFER DOWNLIGHT RETROFIT TRIM

PHYSICAL SPECIFICATIONS
4" RETROFIT TRIM WAFERS

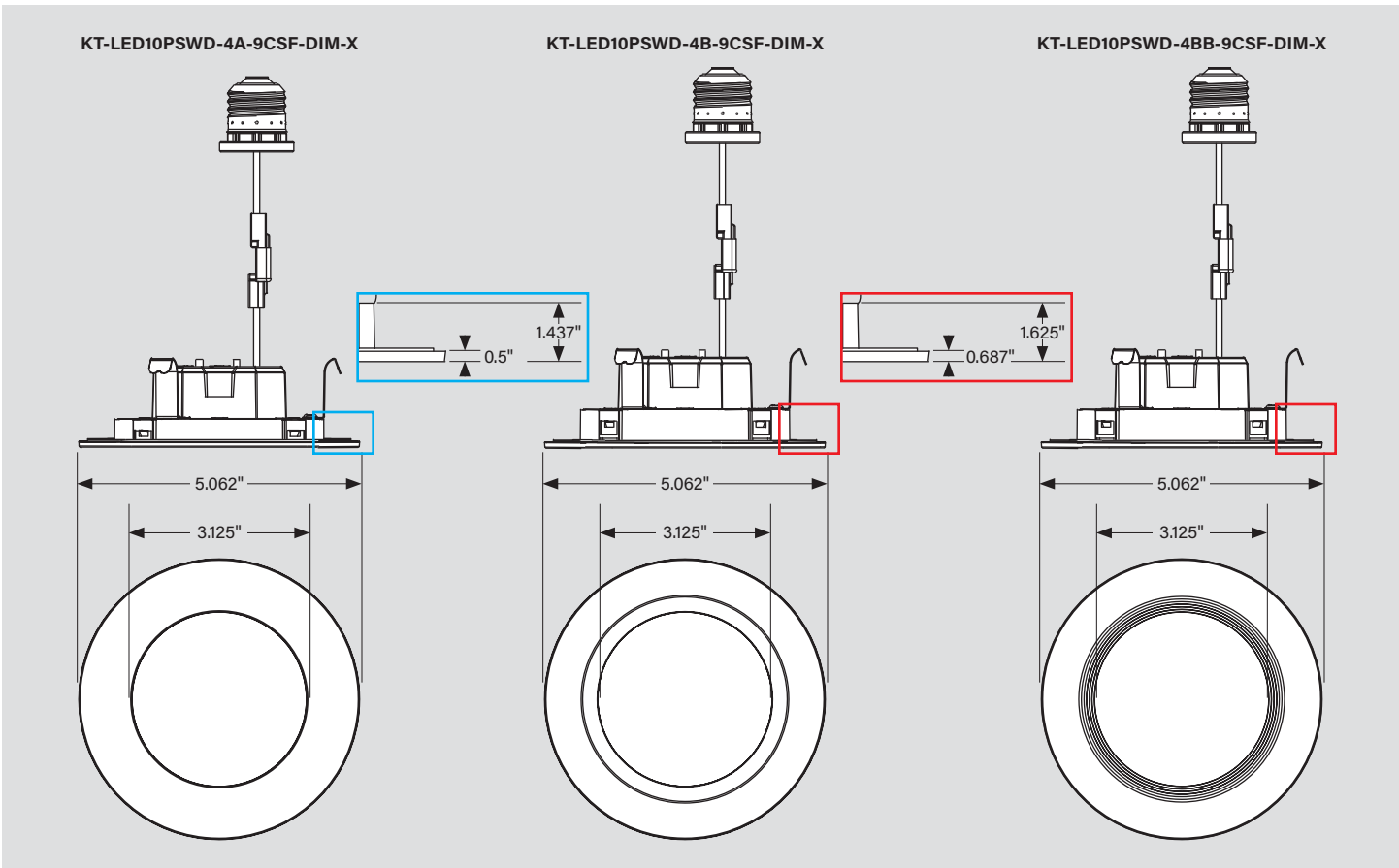

Master Carton Specifications: 4" Retrofit Trim Wafers

Catalog Number	Quantity	Gross Weight	Length	Width	Height
KT-LED10PSWD-4A-9CSF-DIM					
KT-LED10PSWD-4A-9CSF-DIM KT-LED10PSWD-4A-9CSF-DIM-B	12	6.85 lbs	12.36"	10.55"	5.59"
KT-LED10PSWD-4B-9CSF-DIM KT-LED10PSWD-4BB-9CSF-DIM					
KT-LED10PSWD-4B-9CSF-DIM KT-LED10PSWD-4B-9CSF-DIM-B	12	7.00 lbs	13.31"	10.55"	5.59"
KT-LED10PSWD-4BB-9CSF-DIM KT-LED10PSWD-4BB-9CSF-DIM-B		6.98 lbs			

(Physical Specifications continue on next page)

KT-LEDXXPSWD-XX-9CSF-DIM-X

LED WAFER DOWNLIGHT RETROFIT TRIM

PHYSICAL SPECIFICATIONS (CONTINUED)
6" RETROFIT TRIM WAFERS

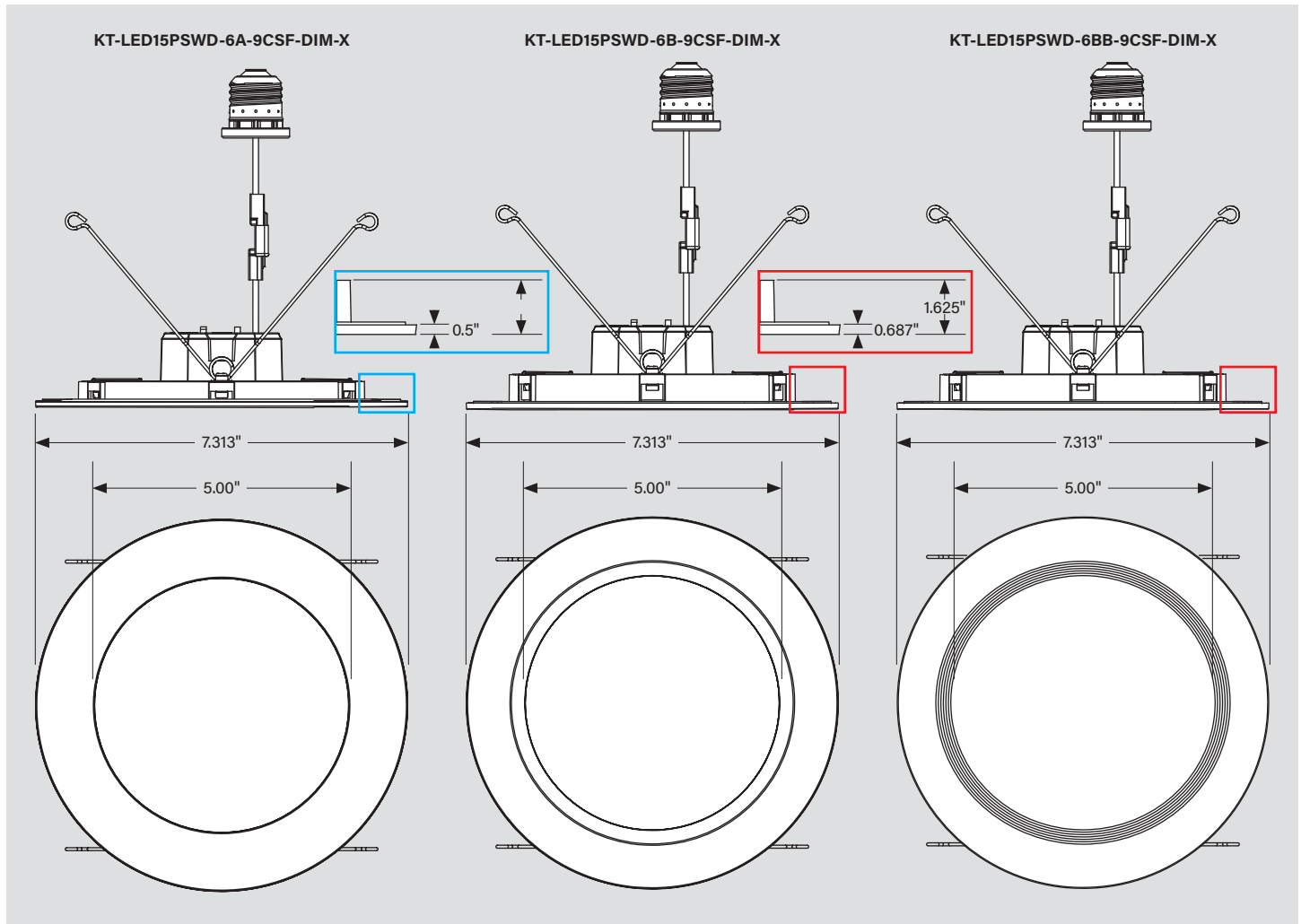

Master Carton Specifications: 6" Retrofit Trim Wafers

Catalog Number	Quantity	Gross Weight	Length	Width	Height
KT-LED10PSWD-6A-9CSF-DIM					
KT-LED15PSWD-6A-9CSF-DIM KT-LED15PSWD-6A-9CSF-DIM-B	12	10.78 lbs	15.35"	11.42"	8.58"
KT-LED10PSWD-6B-9CSF-DIM KT-LED10PSWD-6BB-9CSF-DIM					
KT-LED15PSWD-6B-9CSF-DIM KT-LED15PSWD-6B-9CSF-DIM-B	12	10.93 lbs	15.35"	12.36"	8.58"
KT-LED15PSWD-6BB-9CSF-DIM KT-LED15PSWD-6BB-9CSF-DIM-B		10.95 lbs			

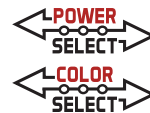

KT-LEDXXPSWD-XX-9CSF-DIM-X

LED WAFER DOWNLIGHT RETROFIT TRIM

POWER SELECT (WATTAGE) AND COLOR SELECT (CCT) ADJUSTMENT

This fixture is equipped with field-adjustable Keystone Power Select and Color Select technology.

1. Ensure power is off to the fixture.
2. Adjust dip switches to desired settings.

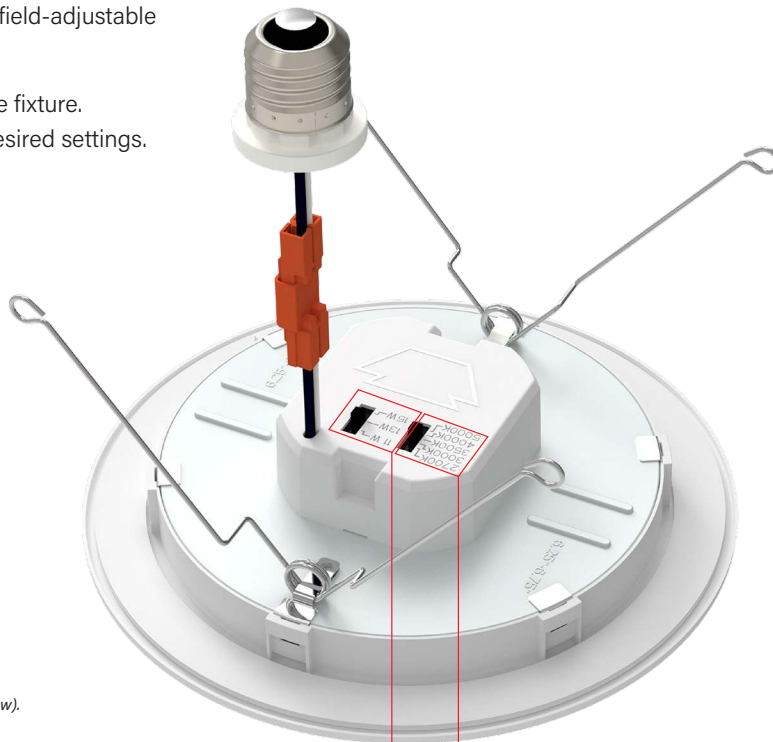

KT-LED15PSWD-6xx-9CSF-DIM shown.
For reference only.
KT-LED10PSWD-4xx-9CSF-DIM SKUs
will show different wattages (see table below).

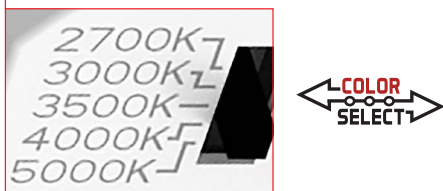
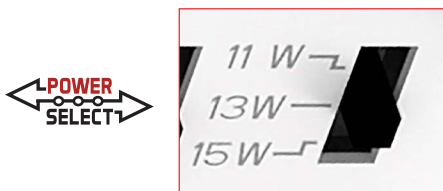

POWER SELECT ADJUSTMENT SWITCH
Power Select dip switch is on the back of the fixture. Choose between high, medium, and low.
Fixture comes preset to highest wattage.
See table below for wattage options.

COLOR SELECT ADJUSTMENT SWITCH
Color Select dip switch is on the back of the fixture. Choose between 2700K, 3000K, 3500K, 4000K, and 5000K.
Fixture comes preset to 2700K.

PART NUMBER	SELECTABLE WATTAGE	SELECTABLE CCT
KT-LED10PSWD-4A-9CSF-DIM KT-LED10PSWD-4A-9CSF-DIM-B		2700K
KT-LED10PSWD-4B-9CSF-DIM KT-LED10PSWD-4B-9CSF-DIM-B	10W 8W 6W	3000K 3500K 4000K 5000K
KT-LED10PSWD-4BB-9CSF-DIM KT-LED10PSWD-4BB-9CSF-DIM-B		
KT-LED15PSWD-6A-9CSF-DIM KT-LED15PSWD-6A-9CSF-DIM-B		2700K
KT-LED15PSWD-6B-9CSF-DIM KT-LED15PSWD-6B-9CSF-DIM-B	15W 13W 11W	3000K 3500K 4000K 5000K
KT-LED15PSWD-6BB-9CSF-DIM KT-LED15PSWD-6BB-9CSF-DIM-B		

KT-LEDXXPSWD-XX-9CSF-DIM-X

LED WAFER DOWNLIGHT RETROFIT TRIM

INSTALLATION INSTRUCTIONS

4" RETROFIT TRIM WAFERS: The existing luminaire housing must be equal to or larger than overall inner dimensions illustrated below.

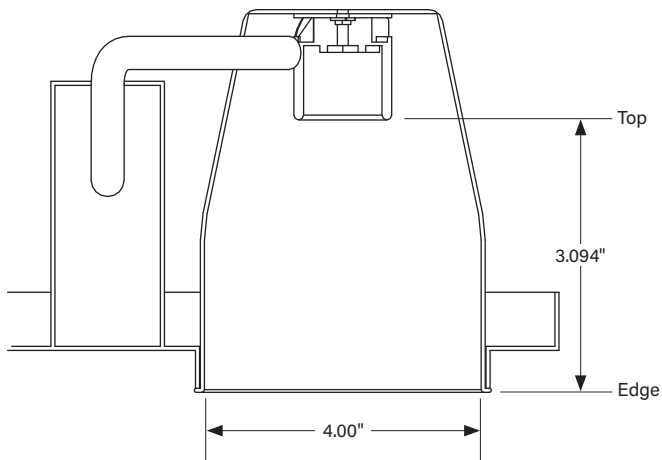

1. Shut off power at the source of the recessed housing into which you are installing fixture.

Remove existing trim and CFL or incandescent bulb.

Note: Follow all federal and local regulations when disposing of lamps and removed components.

2. Unscrew the screws on socket bracket; push bracket upward to the top.

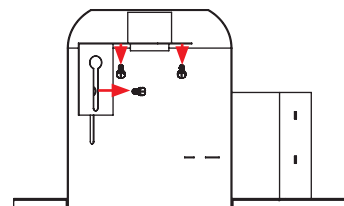

3. Remove existing socket mounting plate from the housing; remove lamp socket from the plate.

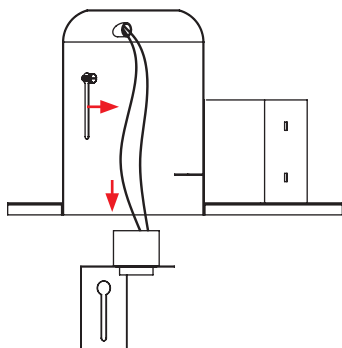

4. Screw E26 adaptor into the socket.

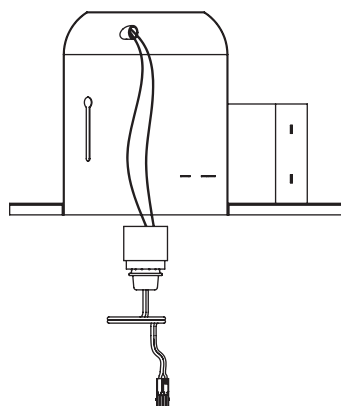

5. Select desired Wattage and CCT using adjustment switches on driver box (see Power Select (Wattage) and Color Select (CCT) Adjustment on page 9).

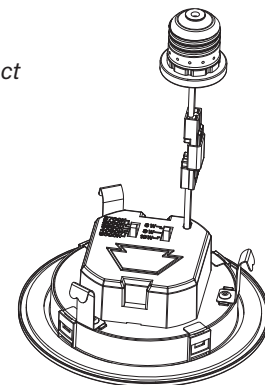

6. Plug E26 base cable connection into the recessed housing.

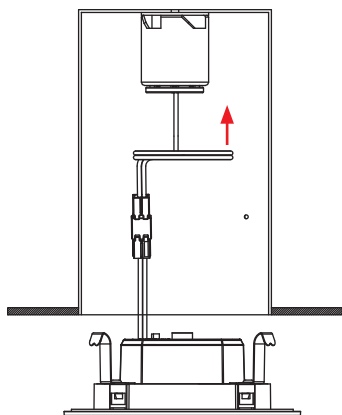

7. Slide friction clips into housing.

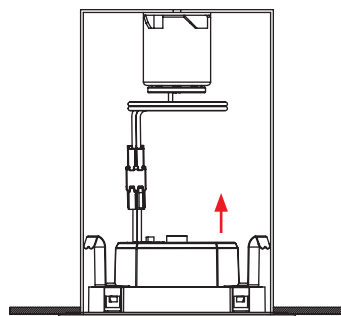

8. Carefully place wires into the fixture, then push the LED trim into the housing until trim is flush with ceiling.

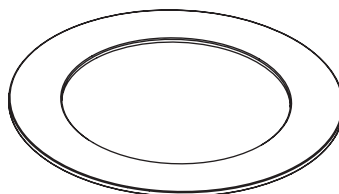

9. Restore power.

Line drawings represent KT-LED10PSWD-4A-9CSF-DIM-X. Installation instructions are the same for all SKUs below:

- KT-LED10PSWD-4A-9CSF-DIM-X
- KT-LED10PSWD-4B-9CSF-DIM-X
- KT-LED10PSWD-4BB-9CSF-DIM-X

(Installation Instructions continue on next page)

KT-LEDXXPSWD-XX-9CSF-DIM-X

LED WAFER DOWNLIGHT RETROFIT TRIM

INSTALLATION INSTRUCTIONS (continued)

6" RETROFIT TRIM WAFERS: The existing luminaire housing must be equal to or larger than overall inner dimensions illustrated below.

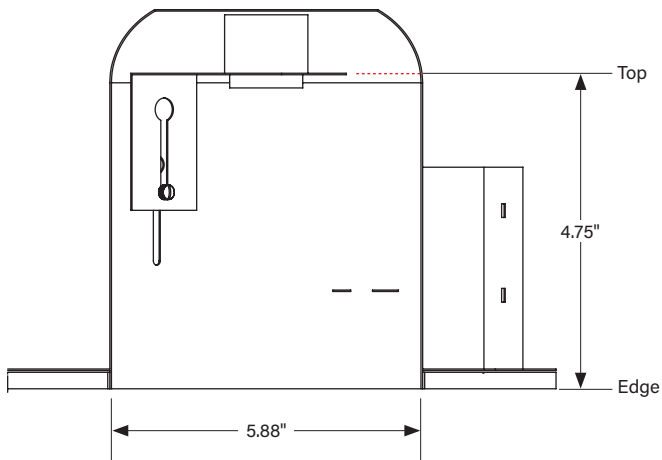

1. Shut off power at the source of the recessed housing into which you are installing fixture.

Remove existing trim and CFL or incandescent bulb.

Note: Follow all federal and local regulations when disposing of lamps and removed components.

2. Unscrew the screws on socket bracket; push bracket upward to the top.

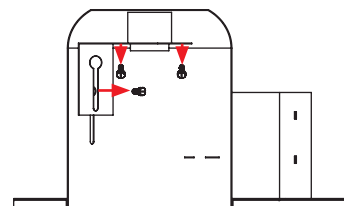

3. Remove existing socket mounting plate from the housing; remove lamp socket from the plate.

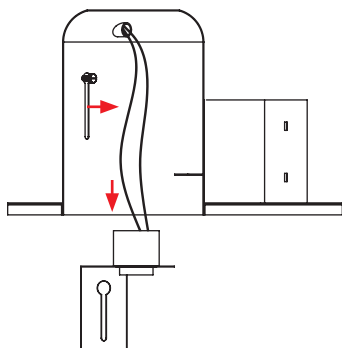

4. Screw E26 adaptor into the socket.

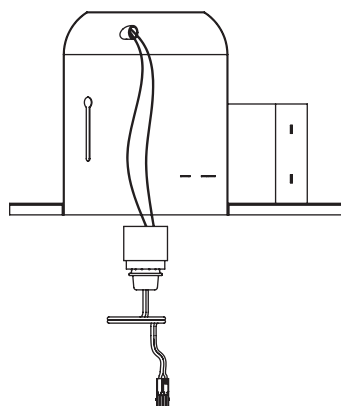

5. Select desired Wattage and CCT using adjustment switches on driver box (see Power Select (Wattage) and Color Select (CCT) Adjustment on page 9).

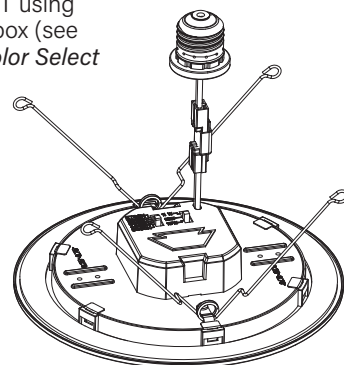

6. Plug E26 base cable connection into the recessed housing.

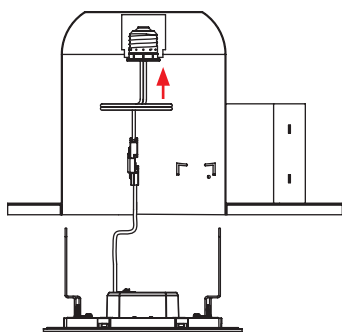

7. Squeeze torsion springs and install into the metal brackets inside the recessed housing. For proper installation, the torsion springs should be seated within the brackets and on both sides of the housing.

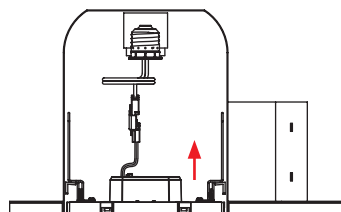

8. Carefully place wires into the fixture, then push the LED trim into the housing until trim is flush with ceiling.

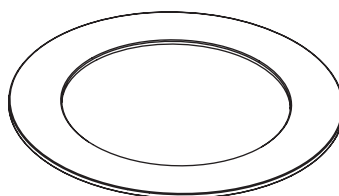

9. Restore power.

Line drawings represent KT-LED15PSWD-6A-9CSF-DIM-X. Installation instructions are the same for all SKUs below:

- KT-LED15PSWD-6A-9CSF-DIM-X
- KT-LED15PSWD-6B-9CSF-DIM-X
- KT-LED15PSWD-6BB-9CSF-DIM-X



KT-LEDXXPSWD-XX-9CSF-DIM-X

LED WAFER DOWNLIGHT RETROFIT TRIM

ORDERING INFORMATION

Catalog Number	UPC	Easy Code	Energy Star ID
KT-LED10PSWD-4A-9CSF-DIM	843654161860	WFE-15	3624274
KT-LED10PSWD-4A-9CSF-DIM-B	843654167763	TSW-98	3942775 3942776
KT-LED10PSWD-4B-9CSF-DIM	843654161877	MSI-34	3624276
KT-LED10PSWD-4B-9CSF-DIM-B	843654167770	XLC-82	3942775 3942776
KT-LED10PSWD-4BB-9CSF-DIM	843654161884	WHR-44	3624275
KT-LED10PSWD-4BB-9CSF-DIM-B	843654167787	TVA-15	3942775 3942776
KT-LED15PSWD-6A-9CSF-DIM	843654161891	PEC-00	3624278
KT-LED15PSWD-6A-9CSF-DIM-B	843654167794	EVS-59	3942777
KT-LED15PSWD-6B-9CSF-DIM	843654161907	XZL-02	3624279
KT-LED15PSWD-6B-9CSF-DIM-B	843654167800	VKR-18	3942777
KT-LED15PSWD-6BB-9CSF-DIM	843654161914	ZFP-40	3624280
KT-LED15PSWD-6BB-9CSF-DIM-B	843654167817	XSK-88	3942777

CATALOG NUMBER BREAKDOWN

KT-LEDXXPSWD-XX-9CSF-DIM-X

- 1
- 2
- 3
- 4
- 5
- 6
- 7
- 8
- 9
- 10
- 11
- 12

- 1** Keystone Technologies
- 2** LED
- 3** Maximum Wattage
- 4** Power Select
- 5** Wafer Style
- 6** Size
- 7** Style Designation
- 8** 90 CRI
- 9** Color Select
- 10** Color Select Designation
- 11** TRIAC Dimming
- 12** Housing Color

6 Size

4	4"
6	6"

7 Style Designation

A	Slim
B	Regressed Smooth
BB	Regressed Baffled

10 Color Select Designation

F	2700/3000/3500/4000/5000K
---	---------------------------

12 Housing Color

	White
B	Black