

KT-MSLED90PS-8-8CSA-VDIM

LED MICROSTRIP FIXTURE

DESCRIPTION

8' LED Microstrip Fixture | 120–277V Input | Frosted Lens | 0–10V Dimming

APPLICATION

Used for commercial, retail, and residential strip applications



PRODUCT FEATURES

- Features Keystone Color Select technology. Adjust CCT between 3500K, 4000K, or 5000K
- Features Keystone Power Select technology. Adjust power between 90W, 75W, and 54W
- Powered by Keystone 0–10V dimming LED drivers
- Post-painted steel body; PMMA lens
- Compatible with Keystone SmartSafe emergency LED drivers
- Compatible with Keystone occupancy sensors
- Ambient operating temperature: –20°C/–4°F to 50°C/122°F
- UL Listed 1598: Suitable for dry and damp locations
- THD: < 20%
- Power factor > 0.95

POWER AND COLOR TEMPERATURE SELECTABILITY

- Keystone Color Select Technology: Adjustable CCT (3500K/4000K/5000K)
- Keystone Power Select Technology: Adjustable Wattage (90W/75W/54W)

PRODUCT SPECIFICATIONS

Catalog Number	Input Voltage	Wattage	Color Temperature	Lumens	Efficacy	Rated Life	CRI	Power Factor
KT-MSLED90PS-8-8CSA-VDIM*	120-277V	90W	3500K	11,880	132 lm/W	50,000 hrs	>80	>0.9
			4000K	11,970	133 lm/W			
			5000K	12,060	134 lm/W			
		75W	3500K	10,125	135 lm/W			
			4000K	10,200	136 lm/W			
			5000K	10,275	137 lm/W			
		54W	3500K	7,668	142 lm/W			
			4000K	7,722	143 lm/W			
			5000K	7,776	144 lm/W			

ONE CATALOG NUMBER WITH 9 DIFFERENT OPTIONS

* Preset to highest lumen output (90W / 5000K)
 * Color Uniformity: CCT (Correlated Color Temperature) range as per guidelines outlined in ANSI C78.377-2017.

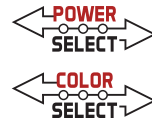

KT-MSLED90PS-8-8CSA-VDIM

LED MICROSTRIP FIXTURE

PHOTOMETRIC SPECIFICATIONS

ISOCANDELA PLOT

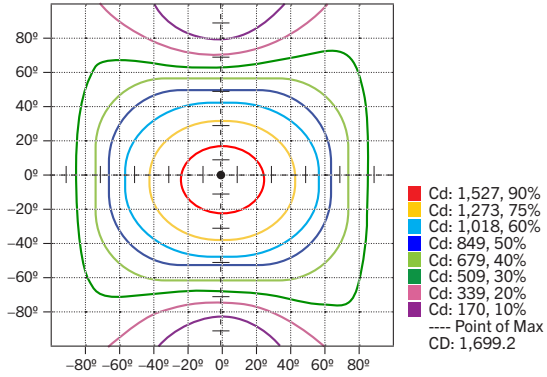

POLAR CANDELA DISTRIBUTION

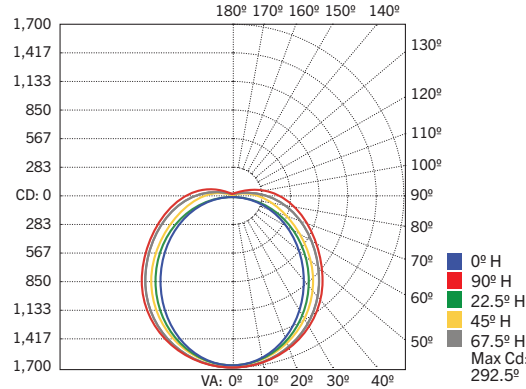

ZONAL LUMEN SUMMARY

Zone	Lumens	% Luminaire
0-30	1,295.9	21.9%
0-40	2,122.9	35.9%
0-60	3,804.3	64.3%
60-90	1,556.1	26.3%
70-100	1,110.0	18.8%
90-120	457.1	7.7%
0-90	5,360.4	90.6%
90-180	553.4	9.4%
0-180	5,913.8	100%

PHYSICAL SPECIFICATIONS

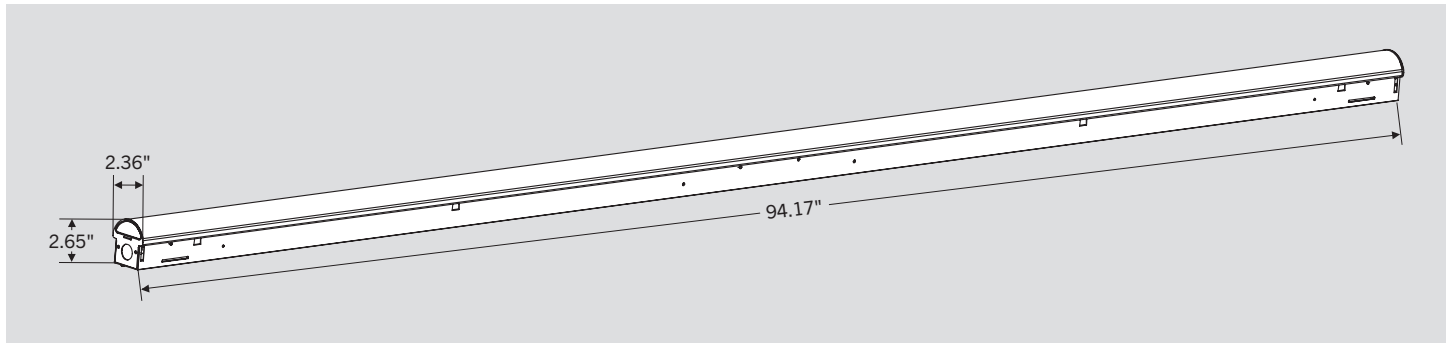

WIRING DIAGRAMS

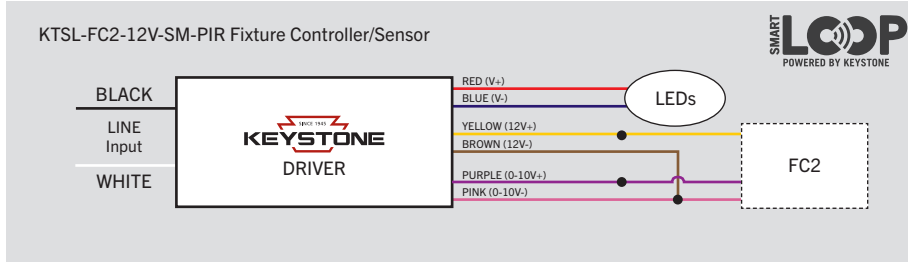
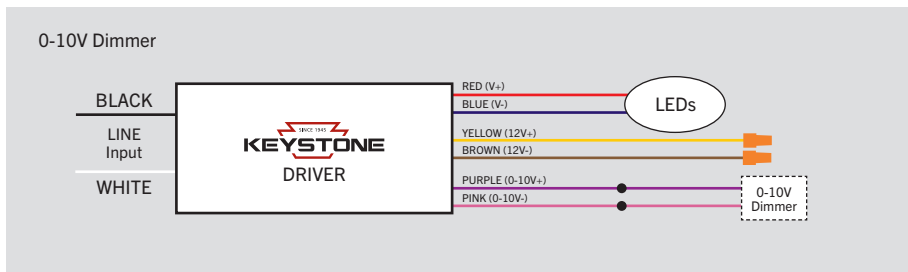

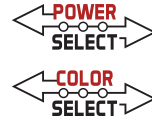

KT-MSLED90PS-8-8CSA-VDIM

LED MICROSTRIP FIXTURE

ACCESSORIES

SENSORS

Factory-Installable OR Field-Installable (field-installable purchased separately)

✓	SUFFIX*	CATALOG NUMBER	DESCRIPTION	UPC	EASY CODE
	/PIR	KTS-PIR2-UV-KO	High Bay PIR Motion Sensor, 120-347V Input. Adjustable Standby Dim level, Hold Times & Daylight Threshold controls. Fixture Mount via 1/2 inch KO	843654123288	I0F-04
	/MW	KTS-MW3-UV-KO-K2	Microwave Sensor Kit, Includes 120-277V input to 12V DC convertor, IP65 12V input sensor head, Nomex Sleeve, Extension Neck. Bi-Level Control with Adjustable Hold Time, Dim Level and Standby Time. Installs via standard 1/2in KO	843654134352	TBV-76
	/FC2	KTSL-FC2-12V-SM-PIR	Bluetooth mesh wireless low voltage individual fixture controller for SmartLoop system with integrated daylight and PIR motion sensors, 12V, 0-10V Dimming	843654135236	TCM-01
	/HBFC1	KTSL-HBFC1-UV-KO-PIR	Bluetooth mesh Wireless Fixture Controller for SmartLoop System with integrated daylight and PIR motion sensor. 120-277V. 3A Max Load with 0-10V Dimming	 843654129266	AEJ-50



Smart Loop PIR Sensor
KTSL-HBFC1-UV-KO-PIR



Fixture installed with KTSL-FC2-12V-SM-PIR
and KT-MSLED-SLB-1 bracket

* FOR FACTORY INSTALLATION OF ACCESSORY, ADD SUFFIX TO FIXTURE PART NUMBER (SEE ORDERING EXAMPLES AND INSTRUCTIONS ON LAST PAGE OF SPEC SHEET).

(Accessories continued on next page)

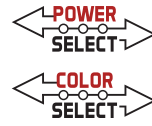

KT-MSLED90PS-8-8CSA-VDIM

LED MICROSTRIP FIXTURE

ACCESSORIES (continued)

CORD SETS

Factory-Installable OR Field-Installable (field-installable purchased separately)

✓	SUFFIX*	CATALOG NUMBER	DESCRIPTION	UPC	EASY CODE
	/515P6	KT-CS-515P-6-18/3	Cord set; 125V NEMA 5-15P; straight blade plug ;6' SJTOW cable; 18/3 wire	843654140124	UKH-26
	/L715P10	KT-CS-L715P-10-16/3	Cord set; 277V NEMA L7-15P; twist lock plug; 10' SJTOW cable; 16/3 wire	843654140131	SFV-88
	/L615P10	KT-CS-L615P-10-16/3	Cord set; 250V NEMA L6-15P; twist lock plug; 10' SJTOW cable; 16/3 wire	843654140148	ZQS-05
	/L515P10	KT-CS-L515P-10-16/3	Cord set; 250V NEMA L5-15P; twist lock plug; 10' SJTOW cable; 16/3 wire	843654140155	GVH-22
	/L715P6	KT-CS-L715P-6-16/3	Cord set; 277V NEMA L7-15P; twist lock plug; 6' SJTOW cable; 16/3 wire	843654140162	DVU-44
	/L615P6	KT-CS-L615P-6-16/3	Cord set; 250V NEMA L6-15P; twist lock plug; 6' SJTOW cable; 16/3 wire	843654140179	LCW-66
	/L515P6	KT-CS-L515P-6-16/3	Cord set; 250V NEMA L5-15P; twist lock plug; 6' SJTOW cable; 16/3 wire	843654140186	POC-82
	/NP10	KT-CS-NP-10-16/3	Cord; no plug; inners 1/2" strip on both ends; 10' SJTOW cable; 16/3 wire	843654140193	YOH-90
	/NP6	KT-CS-NP-6-16/3	Cord; no plug; inners 1/2" strip on both ends; 6' SJTOW cable; 16/3 wire	843654140216	HUB-73
	/NP15	KT-CS-NP-15-16/3	Cord; no plug; inners 1/2" strip on both ends; 15' SJTOW cable; 16/3 wire	843654140209	EYD-18

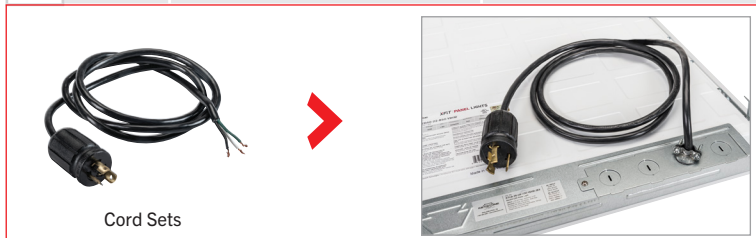

Cord Sets

* FOR FACTORY INSTALLATION OF ACCESSORY, ADD SUFFIX TO FIXTURE PART NUMBER (SEE ORDERING EXAMPLES AND INSTRUCTIONS ON LAST PAGE OF SPEC SHEET).
 NOTE: FOR CORD SETS NOT LISTED HERE, PLEASE CONTACT YOUR KEYSTONE SALES REP.

EMERGENCY BACKUP

Factory-Installable OR Field-Installable (field-installable purchased separately)

✓	SUFFIX*	CATALOG NUMBER	DESCRIPTION	UPC	EASY CODE
	/EM5	KT-EMRG-LED-5C-500-SEN	LED Emergency Back-Up, One Piece Slim 5W Constant Wattage Design, Approx 500 Lumens. 90 Min Operation, 120-277V Input, CEC T20 Compliant. Includes Instruction Sheets, Test Switch, and Wiring Accessories	843654128276	CPO-29
	/EM12	KT-EMRG-LED-12C-1200	LED Emergency Back-Up, 12W Constant Wattage Design. Approx 1200 Lumens. 120-277V Input. Remote Compact Battery Pack. CEC T20 Compliant. Includes Instructions, Test Switch and Wiring Accessories.	843654103112	OJQ-32



5W, 500 lumen Battery Backup
KT-EMRG-LED-5C-500-SEN

12W, 1200 lumen Battery Backup
KT-EMRG-LED-12C-1200

* FOR FACTORY INSTALLATION OF ACCESSORY, ADD SUFFIX TO FIXTURE PART NUMBER (SEE ORDERING EXAMPLES AND INSTRUCTIONS ON LAST PAGE OF SPEC SHEET).
 * FACTORY INSTALLATION OF EMERGENCY BACKUP UNITS WILL AUTOMATICALLY INCLUDE ANY RELEVANT MOUNTING BRACKET.

(Accessories continued on next page)

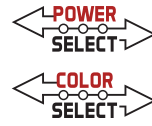

KT-MSLED90PS-8-8CSA-VDIM

LED MICROSTRIP FIXTURE

ACCESSORIES (continued)

MOUNTS AND BRACKETS

Field-Installable / Field-Use **ONLY** (purchased separately)

CATALOG NUMBER	DESCRIPTION	UPC	EASY CODE
KT-MSLED-VH-KIT	V-Hook and Chain Kit for Keystone Micro LED Strip fixtures. Includes (2) V-Hooks and (2) chains 40in long	843654121031	YAK-04
KT-MSLED-SLB-1	Microstrip Bracket for Smart Loop KTSL-FC2-12V-SM-PIR Sensor	843654135472	GGU-95
KT-MSLED-LSM-KIT	Linking Surface Mount Kit for MSLED fixtures. Includes End to End Metal bracket and KO grommet	843654126883	BCV-03

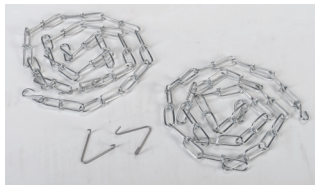

V-Hook and Chain Kit
KT-MSLED-VH-KIT

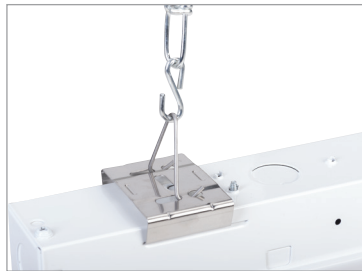

Linking Surface Mount Kit
KT-MSLED-LSM-KIT

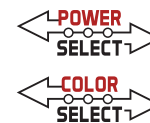

KT-MSLED90PS-8-8CSA-VDIM

LED MICROSTRIP FIXTURE

ORDERING INFORMATION

Order Code	Pack Quantity	Easy Code	UPC
KT-MSLED90PS-8-8CSA-VDIM	1	KQV-13	843654134499

CATALOG NUMBER BREAKDOWN

KT-MSLED90PS-8-8CSA-VDIM

1 2 3 4 5 6 7 8 9

- 1 Keystone Technologies
- 2 LED Microstrip Fixture
- 3 Wattage
- 4 Power Select
- 5 8' Nominal Length
- 6 80 CRI
- 7 Color Select
- 8 Color Select Designation
- 9 0–10V Dimming

8 Color Select Designation

A	3500K, 4000K, 5000K
---	---------------------

ORDERING EXAMPLES

FIXTURE WITH MULTIPLE FACTORY-INSTALLED ACCESSORIES*

KT-MSLED90PS-8-8CSA-VDIM /PIR /NP10/EM5 /VH

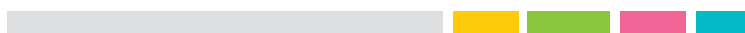

FIXTURE WITH MULTIPLE FACTORY-INSTALLED ACCESSORIES*

KT-MSLED90PS-8-8CSA-VDIM /PIR /EM5 /VH

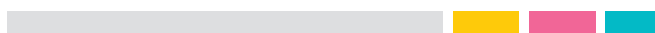

FIXTURE WITH TWO FACTORY-INSTALLED ACCESSORIES*

KT-MSLED90PS-8-8CSA-VDIM /PIR /NP10

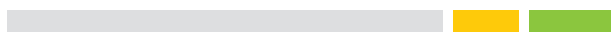

FIXTURE WITH SINGLE FACTORY-INSTALLED ACCESSORY

KT-MSLED90PS-8-8CSA-VDIM /PIR

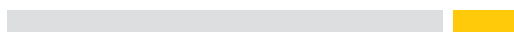

FIXTURE WITH NO FACTORY-INSTALLED ACCESSORIES

KT-MSLED90PS-8-8CSA-VDIM

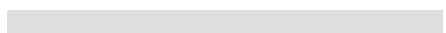

* WHEN ORDERING MORE THAN ONE FACTORY-INSTALLED ACCESSORY, USE MULTIPLE SUFFIXES AS SHOWN IN THE ORDERING EXAMPLES ABOVE.
 NOTE: ALL ACCESSORIES CAN ALSO BE ORDERED SEPARATELY FOR FIELD INSTALLATION USING JUST THEIR REGULAR CATALOG NUMBER, UPC, OR EASY CODE.

KEYSTONE FIXTURE	
CATALOG NUMBER	
KT-MSLED90PS-8-8CSA-VDIM	

SENSORS	
SUFFIX	CATALOG NUMBER
✓ /PIR	KTS-PIR2-UV-KO

CORD SETS	
SUFFIX	CATALOG NUMBER
✓ /NP10	KT-CS-NP-10-16/3

EMERGENCY BACKUP	
SUFFIX	CATALOG NUMBER
✓ /EM5	KT-EMRG-LED-5C-500-SEN

MOUNTS AND BRACKETS	
SUFFIX	CATALOG NUMBER
✓ /VH	KT-MSLED-VH-KIT