

Project:	Type:	Prepared By:	Date:
-----------------	--------------	---------------------	--------------



Features and Benefits

- Produces rich and vibrant colors >90CRI
- Energy efficient replacement for incandescent and halogen Small diameter reflectors
- Constructed from durable materials which lowers risk of breakage
- Rated for use in enclosed and open fixtures in dry or damp locations
- Single optic and full face lens for precise beam angle control
- Longer lifespan compared to legacy equivalents minimizes replacement and maintenance costs
- Title 20 Compliant, ENERGY STAR Compliant, UL Listed
- Compatible with low voltage transformers (check compatibility list)

Technical Specifications		
Performance <hr/> Product Type: Small-Reflector Input Wattage: 7.5W Wattage Equivalency: 75W Halogen Lumens: 560lm Efficacy: 75lm/W L70 Lifespan: 25,000 Hours	LED Characteristics <hr/> Color Temperature: 3000K Warm White Color Accuracy (CRI): ≥90 Beam Angle: 25° Installation <hr/> Base Type: GU5.3 Electrical <hr/> Power Factor: >0.9 Operating Temperature: -20°C to 45°C (-4°F to 113°F) Dimmable: Yes Input Voltage: 12V	Flicker: ≤30% Other <hr/> Warranty: RAB warrants that our LED products will be free from defects in materials and workmanship for a period of five (5) years from the date of delivery to the end user, including coverage of light output, color stability, driver performance and fixture finish. RAB's warranty is subject to all terms and conditions found at rablighting.com/warranty . Compliance <hr/> UL Listed: Yes California Energy Commission (CEC) Status: Lawful for Sales in California <hr/> \
Construction <hr/> Bulb Shape: MR16 For Use Outdoors in Open Fixtures: No		

Case and Pallet Dimensions

	QTY	LENGTH (in)	WIDTH (in)	HEIGHT (in)
CASE	12	8.74	6.61	2
PALLET	5760	44.49	40.47	45.35

Dimension

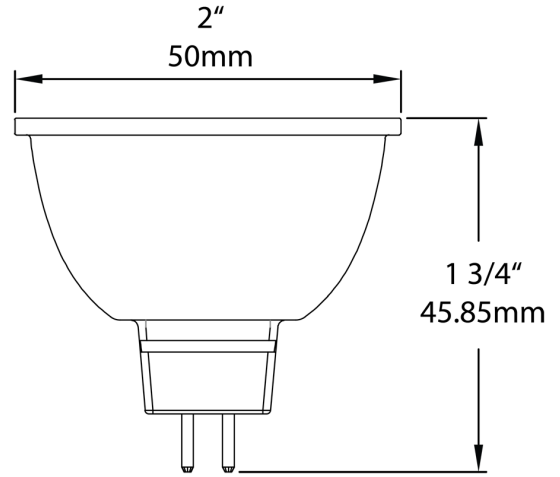

Light Distribution

