



PROJECT NAME: \_\_\_\_\_ CAT. #: \_\_\_\_\_  
 NOTES: \_\_\_\_\_ FIXTURE SCHEDULE: \_\_\_\_\_

## Slim Floods (15W - 60W, higher wattages available on different sheet)



**15W**  
1/2" Threaded Knuckle  
(Dedicated CCT)



**29W**  
1/2" Threaded Knuckle  
(Dedicated CCT)



**50W**  
with Yoke Mount  
(Dedicated CCT)



**15W - 60W**  
1/2" Threaded Knuckle  
(CCT Selectable)

### Product Description:

The MaxLite Slim Flood Light family delivers high performance in a small and price-effective package. All versions are available for a variety of mounting applications - 1/2" threaded knuckle and yoke. Our models come in CCT dedicated, CCT and Wattage selectable with available photocell.

### Construction:

- Die cast aluminum housing with corrosion resistant powder coat paint
- Tempered glass lens or UV stabilized polycarbonate lens (see Specification Chart for details)

### Controls:

- Photocell or twist lock receptacle with shorting cap included (see Specification Chart for details)

### Installation:

- DLC5.1 Versions both 1/2" threaded knuckle and yoke included in carton. Tenon reducer accessory available for slip fitter applications (see Specification Chart for details)
- Non-DLC Versions available with either 1/2" threaded knuckle or a yoke. Tenon reducer accessory available for slip fitter applications (See Specification Chart for details)

### Listings:

- cULus listed for Wet Locations, Outdoor
- IP65
- ANSI 1.5G rated 15-50W, 3G rated 60W

### Ordering Structure (DLC5.1 VERSIONS)

FAMILY	WATTAGE	VOLTAGE	BEAM	-	CCT	FINISH	MOUNTING	CONTROLS (INCLUDED STANDARD)
MSF= Slim Flood	15=15W	U= 120-277V	W= Wide	-	CS= CCT Selectable 3/4/5K	B= Bronze <i>Contact MaxLite for additional finishes</i>	KTY= Knuckle 1/2" Threaded & Yoke (both included in carton), use TR2.37BZ for Slipfitter applications	PC= 120-277V photocontrol
	25= 25W (Selectable 25/20/15) 60= 60W (Selectable 60/40/20)				WCS= Wattage/CCT Selectable			

### Ordering Structure (Non-DLC VERSIONS)

FAMILY	WATTAGE	VOLTAGE	BEAM	-	CCT	FINISH	MOUNTING	CONTROLS
MSF= Slim Flood	15= 15W 29= 29W 50= 50W	U= 120-277V	W= Wide N= Narrow (50W only)	-	30= 3000K 40= 4000K 50= 5000K	B= Bronze <i>Contact MaxLite for additional finishes</i>	KT= Knuckle 1/2" Threaded (use TR2.37BZ for Slipfitter applications) Y= Yoke (factory installed)*	<i>For photocell, order JBOX and PC-120277EXT accessories</i>

\* Yoke Mount is only available for 29W and 50W



**5-year standard warranty** (further details available at [www.maxlite.com/warranties](http://www.maxlite.com/warranties)) Product may be eligible for a warranty extension to 10 years, for an additional fee. Contact MaxLite for details.



## Slim Floods (15W - 60W, higher wattages available on different sheet)

### Stocked Items & DLC 5.1 Listing

Order Codes	Model Number	DLC Product ID	DLC Category	Wattage	CCT
108575	MSF15UW-CSBKTYPC	S-3ID1GP	Outdoor Luminaires - Architectural Flood and Spot Luminaires	15.5W	3000K/4000K/5000K
108576	MSF25UW-WCSBKTYPC	S-CVRS9H		25.5W	
108582	MSF60UW-WCSBKTYPC	S-EK4CZD		59.5W	
104185	MSF15UW-40BKT	N/A	N/A		4000K
104186	MSF15UW-50BKT			5000K	
104188	MSF29UW-30BKT			3000K	
104189	MSF29UW-40BKT			4000K	
104190	MSF29UW-50BKT			5000K	
104192	MSF50UW-40BKT			4000K	
104193	MSF50UW-50BKT			5000K	

### Wattage Selectable Lumen Chart

MSF25	20W= 2,740-2,940 lumens	15W= 2,055-2,205 lumens
MSF60	40W= 5,240-5,880 lumens	20W= 2,620-2,940 lumens

### Accessories

Order Code	Model Number	Description	Image
101679	TR2.37BZ	TENON REDUCER CONVERTS 1/2" KNUCKLE THREADED MOUNT (KT) TO 2 3/8" SLIPFITTER KNUCKLE (SK) MOUNT, BRONZE	
104199	MSF15-HALFVISOR	SLIM FLOOD HALF VISOR FOR 15W <b>(Dedicated CCT versions only)</b>	
104200	MSF15-FULLVISOR	SLIM FLOOD FULL VISOR FOR 15W <b>(Dedicated CCT versions only)</b>	
104201	MSF29-HALFVISOR	SLIM FLOOD HALF VISOR FOR 29W	
104202	MSF29-FULLVISOR	SLIM FLOOD FULL VISOR FOR 29W	
104203	MSF50-HALFVISOR	SLIM FLOOD HALF VISOR FOR 50W	
104204	MSF50-FULLVISOR	SLIM FLOOD FULL VISOR FOR 50W	
104352	GROUNDSTAKE	21" BLACK PVC GROUND STAKE WITH BRONZE DIE CAST CAP, GROUND STABILIZERS BARS AND HARDWARE TO MOUNT TO MOUNT JUNCTION BOX, WHICH ALLOWS ADDING AN EXTERNAL PHOTOCELL	
104350	JBOXB-4TH	JUNCTION BOX WITH 4 1/2" CONDUIT HOLES TOP COVER. PROVIDES MOUNTING FOR FLAT SURFACES AND ADDING EXTERNAL PC (PC-120277EXT)	
101417	PC-120277EXT	EXTERNAL PHOTOCONTROL 120-277V, BLACK FINISH	
105551	MTGCOVER	DIE CAST ALUMINUM MOUNTING COVER WITH 3X1/2" THREADED CONDUIT HOLES, BRONZE	
108915	MSF15-25-CSHALFVISOR	MAXLITE SLIM FLOOD HALF VISOR FOR 15-25W CCT SELECTABLE VERSION	
108918	MSF60-HALFVISOR	MAXLITE SLIM FLOOD HALF VISOR FOR 60W	

## Slim Floods (15W - 60W, higher wattages available on different sheet)

Specifications	15W	25W**	29W	50W	60W**
Power Consumption (W)	15	25.5 (20/15W)	29.5	49.5	59.5 (40/20W)
Lumens (lm)	1,850-2,090	3,480-3,760	3,400-3,430	6,270-6,700	7,790-8,380
Efficacy (lm/w)	123-139	136-147	115-116	127-135	131-141
CRI	>80 (CCT Selectable >70)	>70	>80		>70
Color Temperature (K)	Dedicated & CCT Selectable	CCT Selectable 3/4/5K	3K or 4K or 5K	3K or 4K or 5K	CCT Selectable 3/4/5K
Beam Angle	Wide/7x7/109°	Wide/7x7/111°	Wide/7x7/109°	Wide/7x7/109°, Narrow/4x4/30°	Wide/7x7/112°
Voltage	120-277V 50/60Hz				
Surge Protection	2.5KV				4KV
Lumen Maintenance (L 70) hrs	>100,000 hours				
Controls	PC (CCT Selectable version)	PC	Order JBOX and external PC		PC
Housing	Die cast aluminum with corrosion resistant powder coat paint				
Mounting	See below footnote for details*				
EPA	-0.360ft <sup>2</sup>	-0.360ft <sup>2</sup>	-0.360ft <sup>2</sup>	-0.360ft <sup>2</sup>	-0.360ft <sup>2</sup>
Lens	Dedicated CCT Polycarbonate, CCT Select Tempered Glass	Tempered Glass	UV Stabilized Polycarbonate		Tempered Glass
Operating Temperature	-30°C (-22°F) - 40°C (104°F)				
Weight	Dedicated CCT 1.5lbs CCT Select 3lbs	3lbs		4.5lbs	5lbs
Listings	cULus, FCC, ANSI 1.5G vibration				cULus, FCC, ANSI 3G vibration
DLC	CCT Selectable DLC Premium		Not DLC listed		DLC5.1 Premium
Environment	cULus wet locations, IP65				
Warranty	5 Years				

\* Dedicated CCT - 15W 1/2" threaded knuckle (KT), 29/50W choose between 1/2" threaded knuckle (KT) or yoke (Y)  
CCT Selectable - 15/25/60W both 1/2" threaded knuckle (KT) and yoke (Y) included in carton

For Slipfitter applications (15-60W) - use KT mount and add tenon reducer accessory

\*\* Wattage Selectable, highest wattage DLC listed. See wattage selectable chart for lower wattage lumens.

## Slim Floods (15W - 60W, higher wattages available on different sheet)

### Product Dimensions:

#### Non-DLC MSF

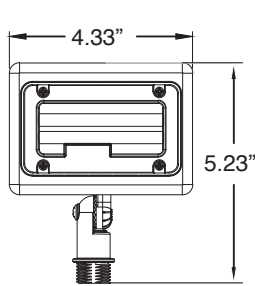

15W 1/2" Threaded Knuckle  
(Dedicated CCT)

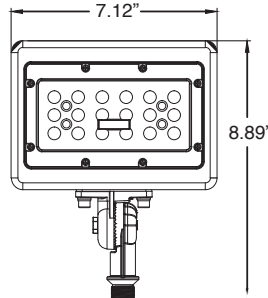

29W 1/2" Threaded Knuckle  
(Dedicated CCT)

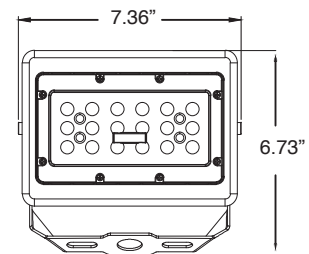
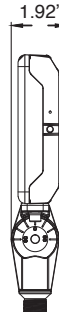

29W Yoke  
(Dedicated CCT)

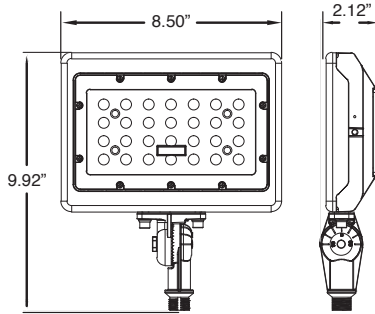
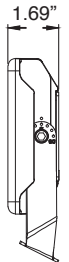

50W 1/2" Threaded Knuckle  
(Dedicated CCT)

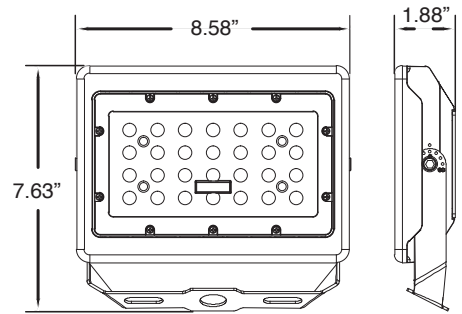

50W Yoke  
(Dedicated CCT)

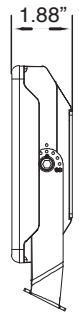

#### DLC MSF

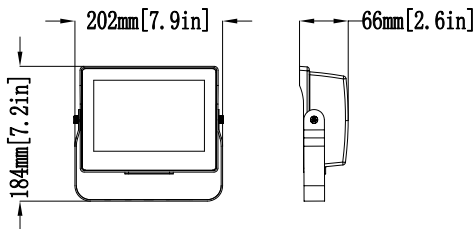

15-25W Yoke (CCT Selectable)

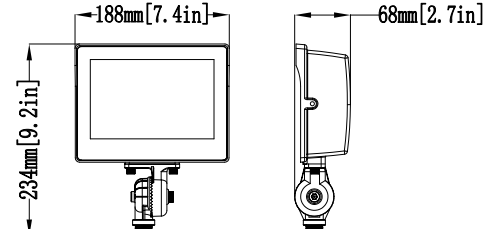
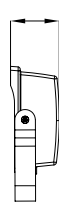

15-25W 1/2" Threaded Knuckle (CCT Selectable)

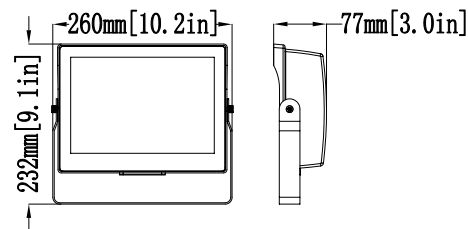
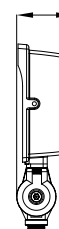

60W Yoke (CCT Selectable)

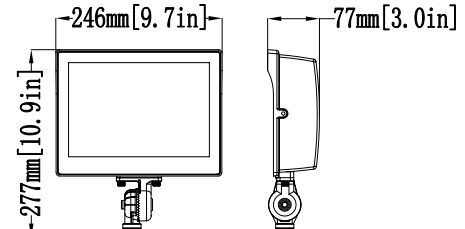
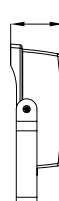

60W Threaded Knuckle (CCT Selectable)



**Slim Floods (15W - 60W, higher wattages available on different sheet)**

## Photometric Layouts\*

\*Units in FC

### Non-DLC MSF

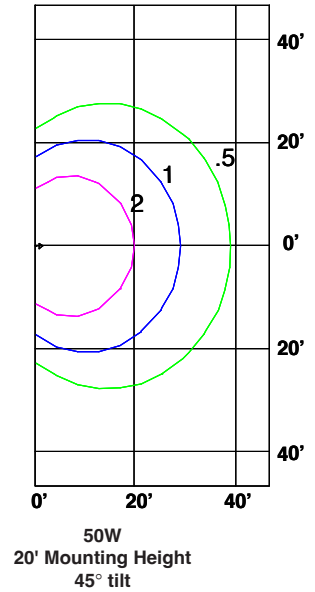
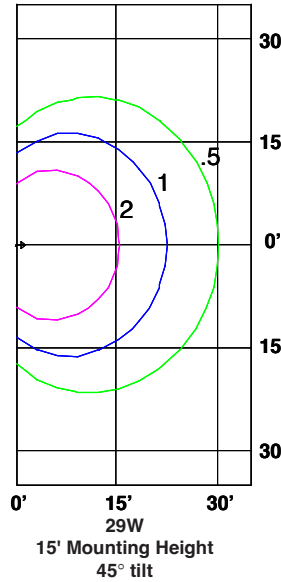
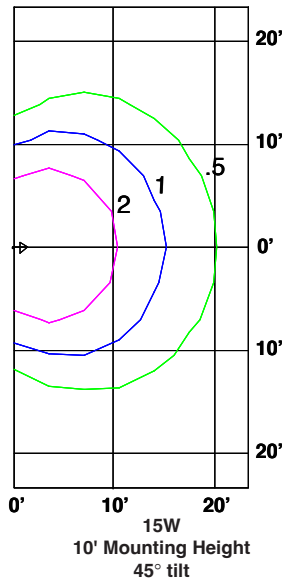

### DLC MSF

