

Project:

Type:

Prepared By:

Date:



UPC: 019813749563

Features and Benefits

- Produces rich and vibrant colors >90CRI
- Energy efficient replacement for incandescent and halogen PAR lamps
- Constructed from durable materials which lowers risk of breakage
- Rated for use in enclosed and open fixtures in dry and damp locations*
- Single optic and full face lens for precise beam angle control
- Longer lifespan compared to legacy equivalents minimizes replacement and maintenance costs
- Title 20 Compliant, UL Listed
- Dimmable down to 10% (check dimmer compatibility list)
- *PAR38 is wet rated

Technical Specifications

Performance

Product Type:

PAR

Input Wattage:

11W

Lumens:

900lm

Efficacy:

82lm/W

L70 Lifespan:

25,000-Hour LED lifespan based on IES LM-70 results

Wattage Equivalency:

75W

LED Characteristics

Color Accuracy (CRI):

90 CRI

Color Temperature:

5000K

Beam Angle:

40°

Electrical

Power Factor:

>0.9

Dimmable:

Yes, down to 10%

Input Voltage:

120V

Operating Temperature:

-20°C to 40°C

Construction

Bulb Shape:

PAR30S

Enclosure Material:

Plastic

Housing Finish:

White

Installation

Base Type:

E26 Edison

Optical

MBCP:

1315

Other

Technology EQ:

Halogen

Warranty:

RAB warrants that our LED products will be free from defects in materials and workmanship for a period of three (3) years from the date of delivery to the end user, including coverage of light output, color stability, driver performance and fixture finish. RAB's warranty is subject to all terms and conditions found at rablighting.com/warranty.

Compliance

UL Listed:

Yes

Technical Specifications (continued)

Environment:

Damp / Enclosed

T20 Compliant:

Yes, Title 20 Tier 2

T24 JA8 Compliant:

Complies with Title 24 Appendix JA8

Rohs:

Mercury and UV free. RoHS-compliant components.

FCC:

Complies with Part 15B of the FCC Rules

\ _____

Case and Pallet Dimensions

	QTY	LENGTH (in)	WIDTH (in)	HEIGHT (in)
CASE	6	12.8	8.5	5
PALLET	864	46.7	38.4	37.8

Dimension

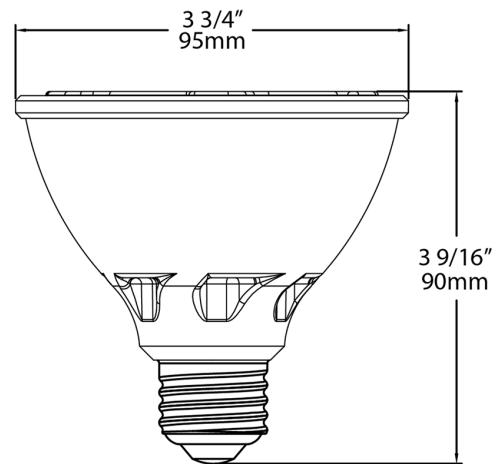

Light Distribution

