



Color: Bronze

Weight: 152.1 lbs

Project:	Type:
Prepared By:	Date:

Technical Specifications

Compliance

CSA Listed:

Suitable for wet locations

Performance

Description:

Steel pole 6" taper 11 gauge 20 foot welded tenon square base

Construction

Base Shaft Diameter:

6"

Hand Holes:

Reinforced with grounding lug and removable cover

Base Plates:

Slotted base plates 36,000 p.s.i.

Color:

Bronze powder coating

Tenon:

Welded 2 3/8" tenon included

Height:

20 ft

Gauge:

11

Wall Thickness:

1/8"

Anchor Bolt Templates:

WARNING Template must be printed on 12" x 18" sheet for actual size. CHECK SCALE BEFORE USING. Templates shipped with anchor bolts and available [online](#).

Max EPA's/Max Weights:

- 70MPH 17.5 ft/550 lb.
- 80MPH 12.6 ft/525 lb.
- 90MPH 8.7 ft/500 lb.
- 100MPH 6.2 ft/500 lb.
- 110MPH 4.4 ft/500 lb.
- 120MPH 3.0 ft/500lb.
- 130MPH 1.8 ft/220 lb.
- 140MPH 1.0 ft/400 lb.
- 150MPH 0.9 ft/390 lb

Accessories:

Base/Cap: [BASE-RT6](#)
Anchor Bolts: [BOLTS-8](#)

Other

Terms of Sale:

Pole Terms of Sale is available [online](#).

Dimensions

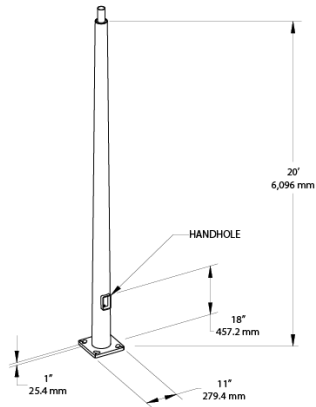

Features

- Designed for ground mounting
- Heavy duty TGIC polyester coating
- Reinforced hand holes with grounding lug and removable cover for easy wiring access
- Pole caps, base covers & bolts are sold separately
- Custom manufactured for each application

Ordering Matrix

Family	Shape	Size	Gauge	Height	Drilled/Welded Tenon
P	TR	6	11	20	WT
	R = Round	4 = 4"	7 = 7	10 = 10'	D2 = Drilled
	TR = Tapered Round	5 = 5"	11 = 11	15 = 15'	WT = Welded Tenon
		6 = 6"		20 = 20'	
		7 = 7"		25 = 25'	
		8 = 8"		30 = 30'	