



Color: Bronze

Weight: 389.1 lbs

Project:	Type:
Prepared By:	Date:

Technical Specifications

Compliance

CSA Listed:

Suitable for wet locations

Performance

Description:

Steel pole 8" taper 7 gauge 30 foot welded tenon square base

Construction

Base Shaft Diameter:

8"

Hand Holes:

Reinforced with grounding lug and removable cover

Base Plates:

Slotted base plates 36,000 p.s.i.

Color:

Bronze powder coating

Height:

30 ft

Gauge:

7

Wall Thickness:

3/16"

Anchor Bolt Templates:

WARNING Template must be printed on 12" x 18" sheet for actual size. CHECK SCALE BEFORE USING. Templates shipped with anchor bolts and available [online](#).

Max EPA's/Max Weights:

- 70MPH 23.1 ft/640 lb.
- 80MPH 15.4 ft/630 lb.
- 90MPH 10.1 ft/620 lb.
- 100MPH 9.7 ft/680 lb.
- 110MPH 6.8 ft/680 lb.
- 120MPH 4.6 ft/670lb.
- 130MPH 2.9 ft/660 lb.
- 140MPH 1.5 ft/650 lb.
- 150MPH 0.4 ft/630 lb

Accessories:

Base/Cap: [BASE-RT8](#)
Anchor Bolts: [BOLT5-8](#)

Other

Terms of Sale:

Pole Terms of Sale is available [online](#).

Dimensions

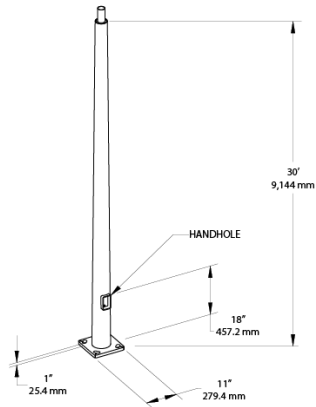

Features

- Designed for ground mounting
- Heavy duty TGIC polyester coating
- Reinforced hand holes with grounding lug and removable cover for easy wiring access
- Pole caps, base covers & bolts are sold separately
- Custom manufactured for each application

Ordering Matrix

Family	Shape	Size	Gauge	Height	Drilled/Welded Tenon
P	TR	8	7	30	WT
	R = Round	4 = 4"	7 = 7	10 = 10'	D2 = Drilled
	TR = Tapered Round	5 = 5"	11 = 11	15 = 15'	WT = Welded Tenon
		6 = 6"		20 = 20'	
		7 = 7"		25 = 25'	
		8 = 8"		30 = 30'	