

LIVC G2 LED LINEAR STAIRWELL, STRIP & VANITY FIXTURE

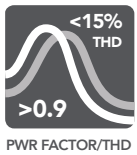

linear lighting flexibility



beautiful uniform illumination

extra wide 6" width to cover old footprint

flex^{CONTROL}COLOR® + flex^{CONTROL}WATT

Eliminate ordering & stocking multiple wattages & color temps! 12 SKUs in 1. Can be in-field configured to 4 wattages & 3 color temps

flex^{CONTROL}CONTROL

Order without controls (control ready), or basic control (integrated bi-level energy saving sensor) or advanced controls

flex^{CONTROL}FIXTURE

Use this fixture in so many places! Multiple end cap trims available allow LIVC G2 to be used as stairwell, vanity & continuous run fixture



JUNCTION BRACKET
For professional looking continuous runs

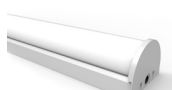

SECURITY END CAP
White metal end cap transforms LIVC into vandal & tamper resistant fixture



MODERN2 END CAP
Double bar brushed-nickel metal end cap creates a premium elegant look

DEFAULT CONFIGURATIONS

PART #	UPC	WATTAGE	LUMENS	LPW	CCT (K)	STAIRWELL DLC PRODUCT CODE	LINEAR AMBIENT DLC PRODUCT CODE
RPT-P-LIVC-G2-2FT-20L-840-FWFC-R-S1	844006010911	10/15/20/30	1240-3750	122-133	3000/3500/4000	PNUZLQCS	PK60JZZJ
RPT-P-LIVC-G2-2FT-20L-840-FWFC-OCC-R-S1	844006010942	10/15/20/30	1240-3750	122-133	3000/3500/4000	PNUZLQCS	PK60JZZJ
RPT-P-LIVC-G2-3FT-20L-840-FWFC-R-S1	844006010928	10/15/20/30	1240-3750	122-133	3000/3500/4000	P0CVHIFA	PGQRP1B2
RPT-P-LIVC-G2-3FT-20L-840-FWFC-OCC-R-S1	844006010959	10/15/20/30	1240-3750	122-133	3000/3500/4000	P0CVHIFA	PGQRP1B2
RPT-P-LIVC-G2-4FT-20L-840-FWFC-R-S1	844006010935	10/15/30/40	1365-5120	123-135	3000/3500/4000	P5QTN26X	PTFYNNUJ
RPT-P-LIVC-G2-4FT-20L-840-FWFC-OCC-R-S1	844006010966	10/15/30/40	1365-5120	123-135	3000/3500/4000	P5QTN26X	PTFYNNUJ

Default settings are above. See page 2 for additional lumen packages, color temperatures and options.



LIGHT EFFICIENT DESIGN HEADQUARTERS 188 S. Northwest Highway • Cary, IL 60013
 INNOVATION & MANUFACTURING CENTER 30 Log Bridge Road, Building 200 • Middleton, MA 01949
 847.380.3540 • led-llc.com

LIVC G2 LED LINEAR STAIRWELL & CORRIDOR FIXTURE



PART NUMBER BUILDER

MFR	CLASS	PRODUCT	GEN	SIZE	WATTAGE	COLOR	FUNCTION	OPTIONS	REF	BAA
RPT	P	LIVC	G2				FWFC		R-S1	

Default setting shown in bold

2FT →	15L, 20L, 30L, 40L	830=3000K/85CRI	FWFC =	OCC = standard motion sensor	BLANK = NON-BAA
3FT →	15L, 20L, 30L, 40L	835=3500K/85CRI	FlexWatt + FlexColor	OCCLR = limited range motion sensor	
4FT →	15L, 20L, 40L, 50L	840=4000K/85CRI		OCCRF = simple grouping motion sensor	
				EMG = 90min emg battery backup	

ORDERING EXAMPLE

FIXTURE RPT-P-LIVC-G2-2FT-15L-840-FWFC-OCC-R-S1

DEFAULT LUMEN PACKAGE (WATTAGE AND CCT) ARE SHOWN BELOW IN BOLD. There are two ways to achieve a non-default lumen package and/or CCT -

1. You can easily adjust in field via our FlexWatt and FlexColor internal switches. 2. Have us adjust the FlexWatt and FlexColor at the factory for an additional charge.

ORDERING GUIDE

	PART #	UPC	WATTAGE	LUMENS	LPW	CCT (K)	STAIRWELL DLC PRODUCT CODE	LINEAR AMBIENT DLC PRODUCT CODE
2FT	RPT-P-LIVC-G2-2FT-15L-830-FWFC-R-S1		10W	1267	127	3000	PV7EH6YP	PR32SWHQ
	RPT-P-LIVC-G2-2FT-15L-835-FWFC-R-S1		10W	1260	126	3500	PV7EH6YP	PR32SWHQ
	RPT-P-LIVC-G2-2FT-15L-840-FWFC-R-S1		10W	1290	129	4000	PV7EH6YP	PR32SWHQ
	RPT-P-LIVC-G2-2FT-20L-830-FWFC-R-S1		15W	1929	129	3000	PNUZLQCS	PK60JZZJ
	RPT-P-LIVC-G2-2FT-20L-835-FWFC-R-S1		15W	1968	131	3500	PNUZLQCS	PK60JZZJ
	RPT-P-LIVC-G2-2FT-20L-840-FWFC-R-S1	844006010911	15W	1994	133	4000	PNUZLQCS	PK60JZZJ
	RPT-P-LIVC-G2-2FT-20L-840-FWFC-OCC-R-S1	844006010942	15W	1994	133	4000	PNUZLQCS	PK60JZZJ
	RPT-P-LIVC-G2-2FT-30L-830-FWFC-R-S1		20W	2572	129	3000	PEPNRUFM	P8GUA4BX
	RPT-P-LIVC-G2-2FT-30L-835-FWFC-R-S1		20W	2624	131	3500	PEPNRUFM	P8GUA4BX
	RPT-P-LIVC-G2-2FT-30L-840-FWFC-R-S1		20W	2659	133	4000	PEPNRUFM	P8GUA4BX
	RPT-P-LIVC-G2-2FT-40L-830-FWFC-R-S1		30W	3806	127	3000	PW0OR59A	P9WFSAH9
	RPT-P-LIVC-G2-2FT-40L-835-FWFC-R-S1		30W	4057	135	3500	PW0OR59A	P9WFSAH9
RPT-P-LIVC-G2-2FT-40L-840-FWFC-R-S1		30W	4099	137	4000	PW0OR59A	P9WFSAH9	
3FT	RPT-P-LIVC-G2-3FT-15L-830-FWFC-R-S1		10W	1267	127	3000	PWJJ0ZQ3	PLPHUGT0
	RPT-P-LIVC-G2-3FT-15L-835-FWFC-R-S1		10W	1260	126	3500	PWJJ0ZQ3	PLPHUGT0
	RPT-P-LIVC-G2-3FT-15L-840-FWFC-R-S1		10W	1290	129	4000	PWJJ0ZQ3	PLPHUGT0
	RPT-P-LIVC-G2-3FT-20L-830-FWFC-R-S1		15W	1929	129	3000	P0CVHIFA	PGQRP1B2
	RPT-P-LIVC-G2-3FT-20L-835-FWFC-R-S1		15W	1968	131	3500	P0CVHIFA	PGQRP1B2
	RPT-P-LIVC-G2-3FT-20L-840-FWFC-R-S1	844006010928	15W	1994	133	4000	P0CVHIFA	PGQRP1B2
	RPT-P-LIVC-G2-3FT-20L-840-FWFC-OCC-R-S1	844006010959	15W	1994	133	4000	P0CVHIFA	PGQRP1B2
	RPT-P-LIVC-G2-3FT-30L-830-FWFC-R-S1		20W	2572	129	3000	P0V2UXXL	PMCLBDQQ
	RPT-P-LIVC-G2-3FT-30L-835-FWFC-R-S1		20W	2624	131	3500	P0V2UXXL	PMCLBDQQ
	RPT-P-LIVC-G2-3FT-30L-840-FWFC-R-S1		20W	2659	133	4000	P0V2UXXL	PMCLBDQQ
	RPT-P-LIVC-G2-3FT-40L-830-FWFC-R-S1		30W	3806	127	3000	PVKFU7E3	PSXYVKZU
	RPT-P-LIVC-G2-3FT-40L-835-FWFC-R-S1		30W	4057	135	3500	PVKFU7E3	PSXYVKZU
RPT-P-LIVC-G2-3FT-40L-840-FWFC-R-S1		30W	4099	137	4000	PVKFU7E3	PSXYVKZU	
4FT	RPT-P-LIVC-G2-4FT-15L-830-FWFC-R-S1		10W	1267	127	3000	PB9AW7G6	PL9KGC3Z
	RPT-P-LIVC-G2-4FT-15L-835-FWFC-R-S1		10W	1260	126	3500	PB9AW7G6	PL9KGC3Z
	RPT-P-LIVC-G2-4FT-15L-840-FWFC-R-S1		10W	1290	129	4000	PB9AW7G6	PL9KGC3Z
	RPT-P-LIVC-G2-4FT-20L-830-FWFC-R-S1		15W	1929	129	3000	P5QTN26X	PTFYNNUJ
	RPT-P-LIVC-G2-4FT-20L-835-FWFC-R-S1		15W	1968	131	3500	P5QTN26X	PTFYNNUJ
	RPT-P-LIVC-G2-4FT-20L-840-FWFC-R-S1	84400601093	15W	1994	133	4000	P5QTN26X	PTFYNNUJ
	RPT-P-LIVC-G2-4FT-20L-840-FWFC-OCC-R-S1	844006010966	15W	1994	133	4000	P5QTN26X	PTFYNNUJ
	RPT-P-LIVC-G2-4FT-40L-830-FWFC-R-S1		30W	3806	127	3000	PS354FRS	P9IB704G
	RPT-P-LIVC-G2-4FT-40L-835-FWFC-R-S1		30W	4057	135	3500	PS354FRS	P9IB704G
	RPT-P-LIVC-G2-4FT-40L-840-FWFC-R-S1		30W	4099	137	4000	PS354FRS	P9IB704G
	RPT-P-LIVC-G2-4FT-50L-830-FWFC-R-S1		40W	4909	123	3000	PR5XBIAL	PNREHV6W
	RPT-P-LIVC-G2-4FT-50L-835-FWFC-R-S1		40W	5347	134	3500	PR5XBIAL	PNREHV6W
RPT-P-LIVC-G2-4FT-50L-840-FWFC-R-S1		40W	5329	133	4000	PR5XBIAL	PNREHV6W	



LIGHT EFFICIENT DESIGN HEADQUARTERS 188 S. Northwest Highway • Cary, IL 60013
 INNOVATION & MANUFACTURING CENTER 30 Log Bridge Road, Building 200 • Middleton, MA 01949
 847.380.3540 • led-llc.com

08.04.20 Information is subject to change without notice.

LIVC G2 LED LINEAR STAIRWELL & CORRIDOR FIXTURE



HOW DOES IT WORK?

We custom designed our own LED driver in-house so that the driver operates at maximum efficiency at each wattage. Standard LED drivers would have reduced efficiency.

WHAT ARE THE WATTAGE CHOICES?

The 2ft, 3ft & 4ft length fixtures all have different wattage/lumen offerings. Please reference this table and the ordering guide on the last page of the cut sheet.

FLEXWATT TURN DIAL POSITION				
LENGTH	0	1	2	3
2FT	10W (1500LM)	15W (2000LM)	20W (3000LM)	30W (4000LM)
3FT	10W (1500LM)	15W (2000LM)	20W (3000LM)	30W (4000LM)
4FT	10W (1500LM)	15W (2000LM)	30W (4000LM)	40W (5000LM)

HOW EASY IS IT TO SET?

Simply open the fixture, and adjust the 4-position turn dial with a small, flat-head screw driver. Takes 30 seconds max. Can be "locked-out" to prevent field-adjustability if desired.

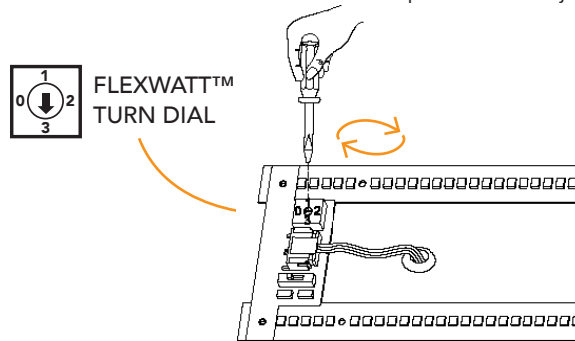

HOW DOES IT WORK?

We select the highest efficacy, multiple color LED diodes from quality suppliers, and mount them on the same circuit board. A proprietary LED binning process ensures color consistency between fixtures. The FlexColor technology controller ensures the correct color is selected, every time.

WHAT ARE THE COLOR CHOICES?

The 2ft, 3ft & 4ft length fixtures all have the same 3 choices for color temperature. 3000k, 3500k and 4000k. Please reference this table and the ordering guide on the last page of the cut sheet.

FLEXCOLOR SLIDE SWITCH POSITION			
LENGTH	TOP	MIDDLE	BOTTOM
2FT	3000K	3500K	4000K
3FT	3000K	3500K	4000K
4FT	3000K	3500K	4000K

HOW EASY IS IT TO SET?

Simply open the fixture, and adjust the 3-position slide switch with your fingers. Takes 30 seconds max. Can be "locked-out" to prevent field-adjustability if desired.

FLEXCOLOR™ SLIDE SWITCH

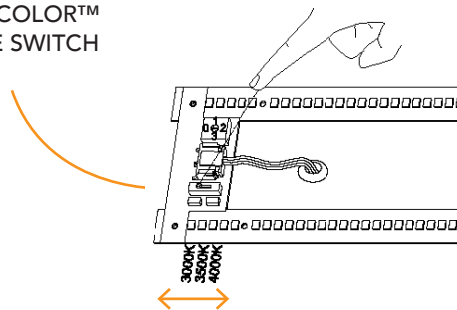

LIGHT EFFICIENT DESIGN HEADQUARTERS 188 S. Northwest Highway • Cary, IL 60013
 INNOVATION & MANUFACTURING CENTER 30 Log Bridge Road, Building 200 • Middleton, MA 01949
 847.380.3540 • led-llc.com

LIVC G2 LED LINEAR STAIRWELL & CORRIDOR FIXTURE



DIMENSIONS

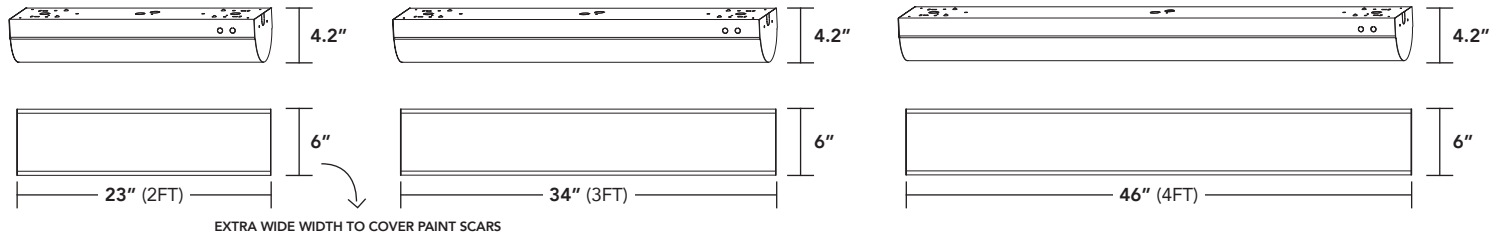

CONTROL OPTIONS

CONTROL READY

All LIVC G2 models come standard as factory enabled to add controls at the factory, in the field or at a later date. Driver comes with 10V dimming and 12V DC power wiring.

BASIC CONTROL

Integrated high frequency, high/low motion and daylight hold-off sensor. Can be mounted behind glass or plastic lens. Default settings: SENSITIVITY: 100%, TIME DIM: 5MIN, TIME OFF = +∞ (dim but never off), PHOTOCCELL: DISABLED, DIM LEVEL: 30%. Purchase optional remote control separately to adjust settings.

ORDERING CODES
 SENSOR = OCC / REMOTE CONTROL = REMOTE-IR12

ADVANCED WIRELESS CONTROL

We partner with Magnum, avi-on, Philips, Lutron and other intelligent wireless lighting control systems. Allows for occupancy sensing, daylight harvesting, grouping, scheduling, high-end trim and more. Adjust settings via iPhone/Android apps. Contact us for

CONTACT US FOR ORDERING CODES

ACCESSORIES

SECURITY END CAP
 White metal end cap transforms LIVC into vandal & tamper resistant fixture.
USES prisons, university dorms, apartment buildings
RPT-P-LIVC-G2-ENDCAP-SECURITY1

MODERN1 END CAP
 Single bar brushed-nickel metal end cap creates a premium elegant look
USES hotels, high-end apartments, bathroom vanity
RPT-P-LIVC-G2-ENDCAP-MODERN1

MODERN2 END CAP
 Double bar brushed-nickel metal end cap creates a premium elegant look
USES hotels, high-end apartments, bathroom vanity or mount fixture vertically for a beautiful wall sconce
RPT-P-LIVC-G2-ENDCAP-MODERN2

ACCESSORIES

JUNCTION BRACKET
 For professional looking continuous runs
RPT-P-LIVC-G2-JUNCTION-WHT

V-HOOK
 Used to hang the LIVC from chain or cable (Includes 2 V-Hooks; chain/cable not included)
RPT-P-LIVC-G2-VHOOK-SET



LIGHT EFFICIENT DESIGN HEADQUARTERS 188 S. Northwest Highway • Cary, IL 60013
 INNOVATION & MANUFACTURING CENTER 30 Log Bridge Road, Building 200 • Middleton, MA 01949
 847.380.3540 • led-llc.com

08.04.20 Information is subject to change without notice.

LIVC G2 LED LINEAR STAIRWELL & CORRIDOR FIXTURE

SENSOR OPTIONS: OCC / OCCLR

- OCC** Standard high/low motion sensor
 - Remote IR12
- OCCLR** Limited range high/low motion sensor
 - Remote IR12

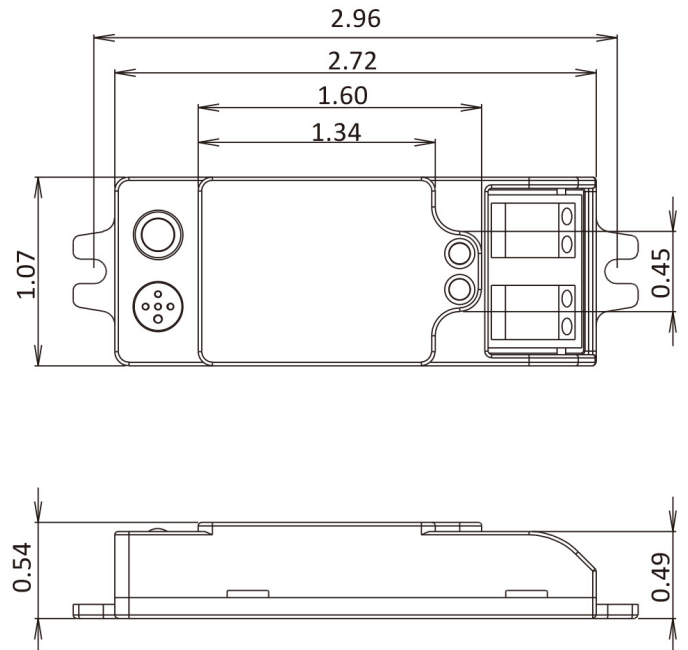
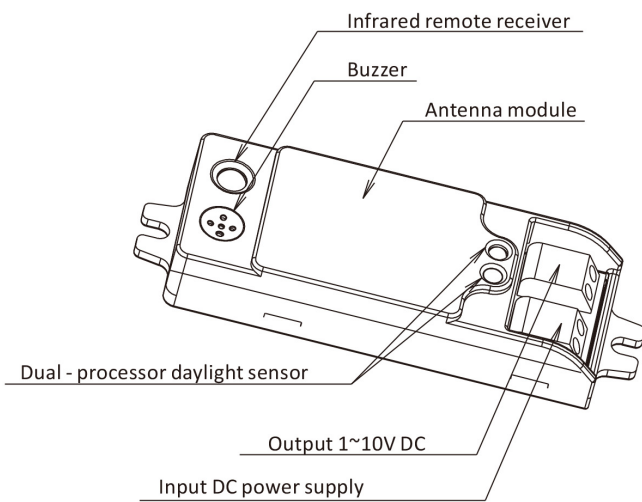

- occupancy sensor w/ daylight hold-off
- powered by 12V DC LED driver from fixture
- high frequency radar occupancy sensor
- infrared remote control available (sold separately)
- uses less than 0.1W in standby mode



LIVC G2 LED LINEAR STAIRWELL & CORRIDOR FIXTURE

DETECTION PATTERN OCC (STANDARD OPTION)

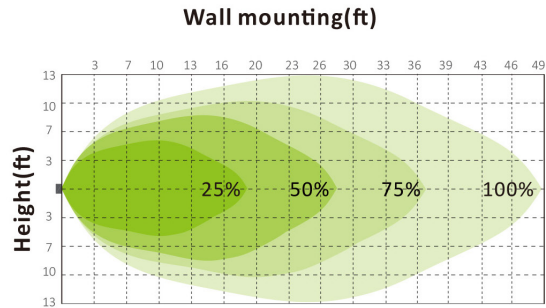
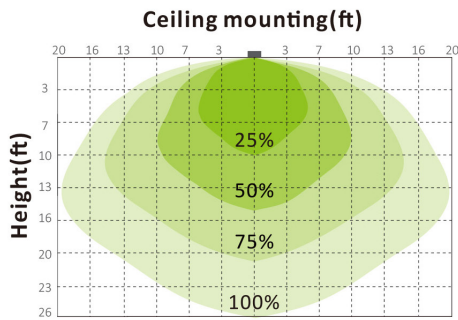

DETECTION PATTERN OCCLR (LIMITED RANGE)

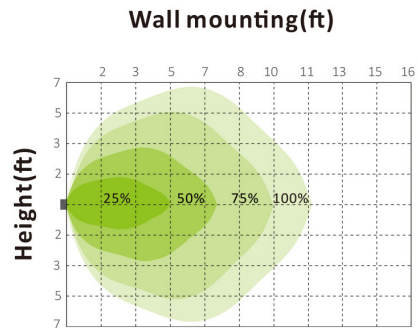
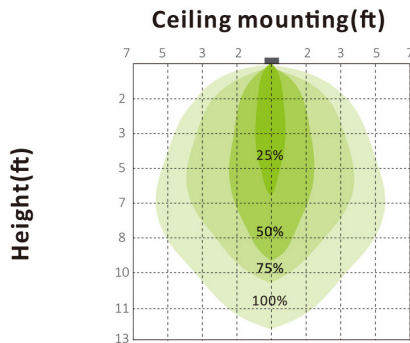

DAYLIGHT MONITORING FUNCTION

This sensor can tell the difference between natural light and artificial light (lamp) from behind the diffuser, switch on automatically (even without movements) when the ambient light is below the target value, and then switch off automatically whenever the artificial light is not required (ambient light is bright enough).

Note: Lux-Off sampling time - 30s; Lux-On sampling time - 10s

Lux-On function will only operate without motion when standby is set to + ∞.

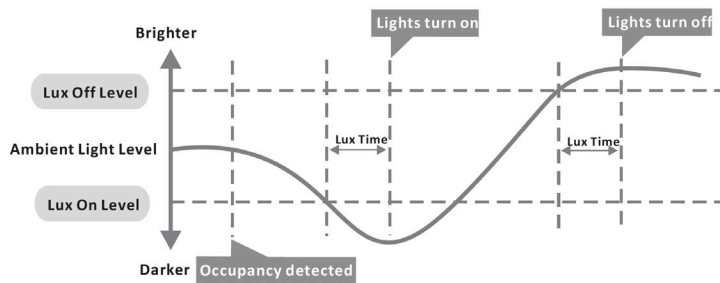

LIGHT EFFICIENT DESIGN HEADQUARTERS 188 S. Northwest Highway • Cary, IL 60013
 INNOVATION & MANUFACTURING CENTER 30 Log Bridge Road, Building 200 • Middleton, MA 01949
 847.380.3540 • led-llc.com

LIVC G2 LED LINEAR STAIRWELL & CORRIDOR FIXTURE

SENSOR OPTIONS: OCC / OCCLR



Permanent ON/OFF function

Press "POWER" button, sensor is disabled.

*press "Auto", "Reset" or "Ambient learn" to quit this mode.



Dim +/-

Press "Dim" button to automatically dim up or down the light brightness during hold-time from 10% to 100%. Another press to lock it down when desired brightness is achieved.

*after desired brightness is locked down, if user wants to dim again reversely, just press the "Dim" button again and then lock down the new brightness again.



Sensor mode

Press "Auto" button, the sensor starts to work and all settings remain the same as the latest status before the sensor was disabled.



Reset function

Press "Reset" button, all settings go back to factory default settings.

* Factory default settings--

Sensitivity=100%
Daylight sensor=disable
Hold time=5min
Twilight time=+∞
Twilight level=30%



Ambient learn

Press "Ambient learn" button, the latest surrounding lux value overwrites previous lux value learned, and set as the daylight threshold. This feature enables the fixture to function well in any real application circumstance.



Test mode

"Test mode" is for testing purpose only, for users to check the functionality and choose the desired detection range. The sensor goes to test mode automatically after pressing this button.

Users can quit this mode by pressing "ON/OFF", "Reset", or any button of "Hold time". The sensor settings are changed accordingly.

* Test mode defaulted settings--

Daylight sensor=disable
Hold time=3s
Twilight time=N/A
Twilight level=N/A



IR12

Note:

- The buzzer short beeps (~0.5s) ONCE when sensor successfully receives RC signal after pressing any buttons except for "Ambient learn".
- The buzzer short beeps (~0.5s) TWICE to start learning ambient lux after pressing "Ambient learn". Then followed by a long beep (~1s) to indicate the success of ambient learning.
- When "twilight level" set at 0%, it becomes ON/OFF control.



Light Efficient Design

LIGHT EFFICIENT DESIGN HEADQUARTERS 188 S. Northwest Highway • Cary, IL 60013
INNOVATION & MANUFACTURING CENTER 30 Log Bridge Road, Building 200 • Middleton, MA 01949
847.380.3540 • led-llc.com

08.04.20 Information is subject to change without notice.

LIVC G2 LED LINEAR STAIRWELL & CORRIDOR FIXTURE



SENSOR OPTIONS: OCCRF (SIMPLE GROUPING SENSOR)

- OCCRF Simple grouping high/low motion sensor
- Remote IR13

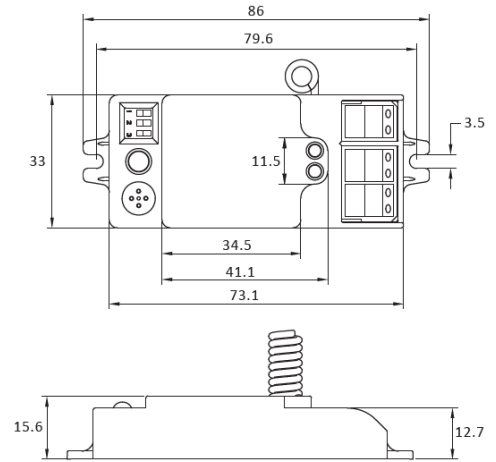
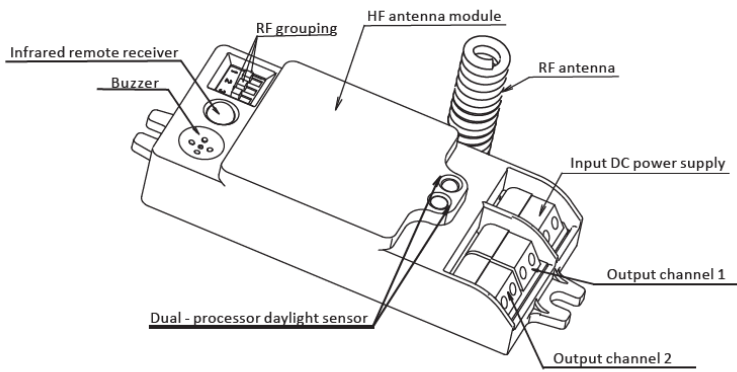

- simple grouping motion sensor w/ daylight hold-off
- powered by 12V DC LED driver from fixture LED driver
- max 150 ft grouping range
- ideal for stairways, parking garages and hallways
- grouping by remote or dip switch (infrared remote control sold separately)
- uses less than 0.1W in standby mode



LIVC G2 LED LINEAR STAIRWELL & CORRIDOR FIXTURE



DETECTION PATTERN OCCRF

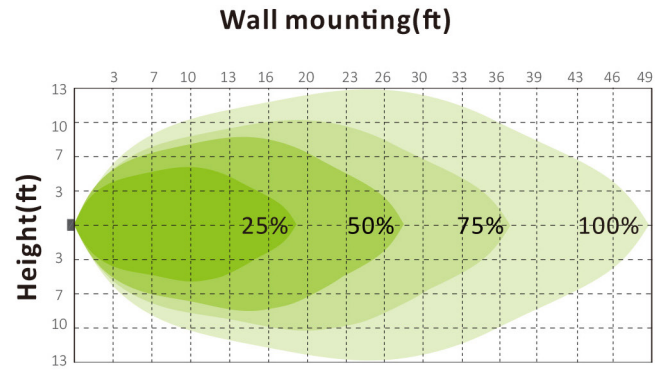
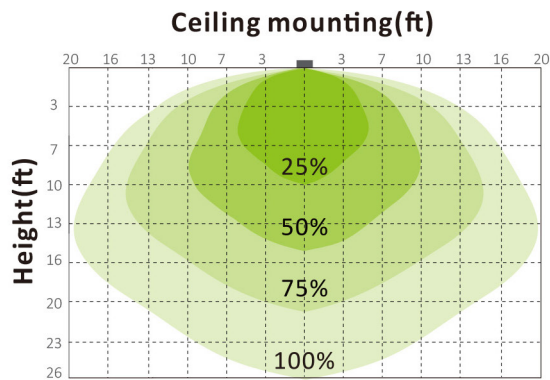

DAYLIGHT MONITORING FUNCTION

This sensor can tell the difference between natural light and artificial light (lamp) from behind the diffuser, switch on automatically (even without movements) when the ambient light is below the target value, and then switch off automatically whenever the artificial light is not required (ambient light is bright enough).

Note: Lux-Off sampling time - 30s; Lux-On sampling time - 10s

Lux-On function will only operate without motion when standby is set to + ∞.

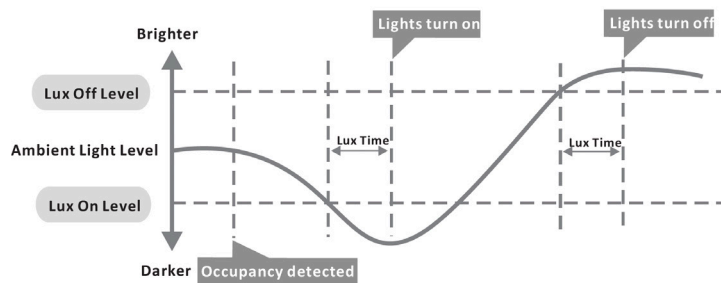

LIGHT EFFICIENT DESIGN HEADQUARTERS 188 S. Northwest Highway • Cary, IL 60013
 INNOVATION & MANUFACTURING CENTER 30 Log Bridge Road, Building 200 • Middleton, MA 01949
 847.380.3540 • led-llc.com

LIVC G2 LED LINEAR STAIRWELL & CORRIDOR FIXTURE

SENSOR OPTION: OCCRF (SIMPLE GROUPING SENSOR)

OCC OFF function

Press "OCC OFF" button, the motion sensor will be disabled.

*press "OCC ON", "Reset" or "Ambient" to re-activate the motion sensor.

Dim

Press "Dim" button to automatically dim up or down the light brightness during hold-time from 10% to 100%. Another press to lock it down when desired brightness is achieved.

*After desired brightness is locked down, if user wants to dim again reversely, just press the "Dim" button again and then lock down the new brightness again.

OCC ON function

Press "OCC ON" button, the sensor starts to work and all settings remain the same as the latest status before the light was switched on / off.

Reset function

Press "Reset" button, all sensor settings go back to factory default settings.

* Factory default setting:

Sensitivity=100%
Daylight sensor=disable
Hold time=90s
Twilight time=5min
Twilight level=10%
CCT=Neutral

Ambient learn

Press "Ambient learn" button, the latest surrounding lux value overwrites previous lux value learned, and set as the daylight threshold. This feature enables the fixture to function well in any real application circumstance.

Test mode

"Test mode" is for testing purpose only, for users to check the functionality and choose the desired detection range. The sensor goes to test mode automatically after pressing this button.

Users can quit this mode by pressing "ON/OFF", "Reset", or any button of "Hold time". The sensor settings are changed accordingly.

* Test mode defaulted settings--
Daylight sensor=disable
Hold time=3s
Twilight time=N/A
Twilight level=N/A

In this mode, when used for on/off control, after motion detected, sensor enters into a cycle of 3s on and 2s off.

In this mode, when used for tri-level dimming control, after motion detected, sensor enters into a cycle of 3s on and 2s off (0.5s soft off + 1.5s off).



Note:

- The buzzer short beeps (~0.5s) ONCE when sensor successfully receives RC signal after pressing any buttons except for "Ambient learn".
- The buzzer short beeps (~0.5s) TWICE to start learning ambient lux after pressing "Ambient learn" Then followed by a long beep (~1s) to indicate the success of ambient learning.
- When "twilight level" set at 0%, it becomes ON/OFF control.
- Function zone of "CCT Adjust" is invalid for this model.

LIVC G2 LED LINEAR STAIRWELL & CORRIDOR FIXTURE



SENSOR OPTION: OCCRF (SIMPLE GROUPING SENSOR)

RF Grouping (via remote control)

- Learn** Short press “Learn” button to the receiver unit to start grouping mode, the receiver unit will beep quickly (every second for 3min). This grouping mode will last for 3min, second short press on it will quit the grouping mode.
- Send** Short press “Send” button to the commander unit, it will beep once to start a 5s RF signal sending, and then beep twice to indicate finish of it. After receiving the RF signal, the receiver unit will beep 1s to indicate the success of grouping.
- Erase** Long press “Erase” button for 5s to the sensor unit, it will long beep once, to indicate the success of erasing.

Note:

1. If you want the sensor to work as both commander and receiver , you need to repeat the “learn” and “send” process again with the identification exchanged.
2. Each receiver can learn up to max. 32 commanders, commanders added beyond 32pcs will automatically substitute earlier ones.
3. Before using the remote control for grouping, you have to position the grouping DIP switch at OFF - OFF - OFF. (default from factory)

Steps for grouping with remote control:

Step 1: Press “Learn” button on sensor A



Step 2: Press “Send” button on sensor B



Step 4: Press “Send” button on sensor A



Step 3: Press “Learn” button on sensor B

Fast RF Grouping (via DIP switch)

By simply selecting the same channel on each sensor unit, the grouping is quickly and automatically completed. Totally 7 channels are available for fast grouping.

* Channel OFF - OFF - OFF is not for fast grouping, it is for remote control grouping only.



LIVC G2 LED LINEAR STAIRWELL & CORRIDOR FIXTURE

SENSOR OPTION: OCCRF (SIMPLE GROUPING SENSOR)

ILLUSTRATION FOR TYPICAL PARKING GARAGE APPLICATION

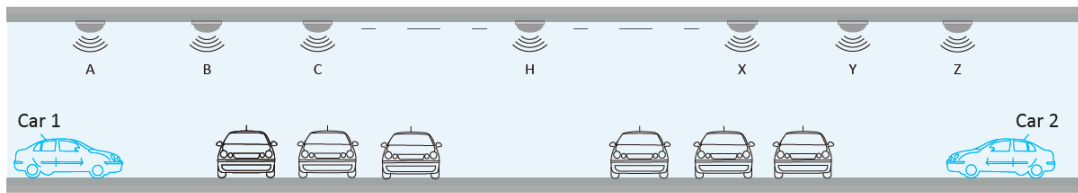

With sufficient daylight, sensor will not be triggered by motion, all lamps are off.

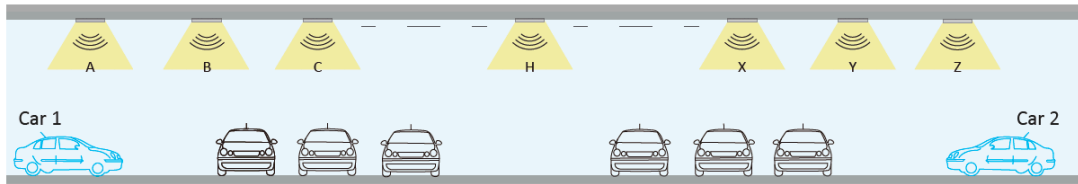

With insufficient natural light, either car 1 or car 2 enters the garage, sensor A or Z will be triggered on, and send RF signal simultaneously to all grouped sensors, all lamps will be 100% ON.

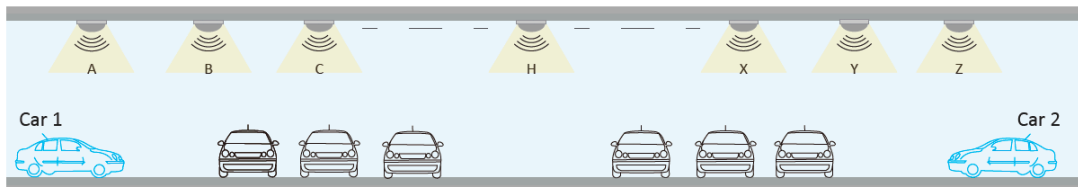

After the hold-time, the whole grouped lamps will dim to pre-defined dimming level (e.g., 10%) if no further movement detected.

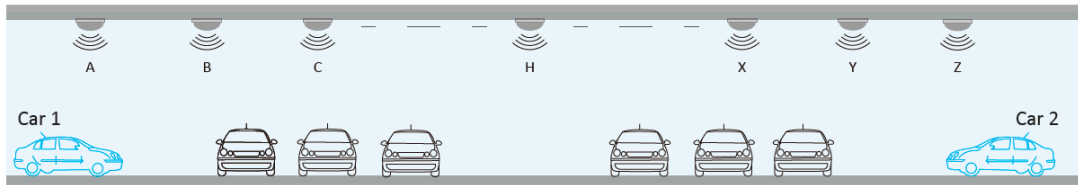

The whole grouped lamps will switch off automatically after the stand-by period if no further movement detected.

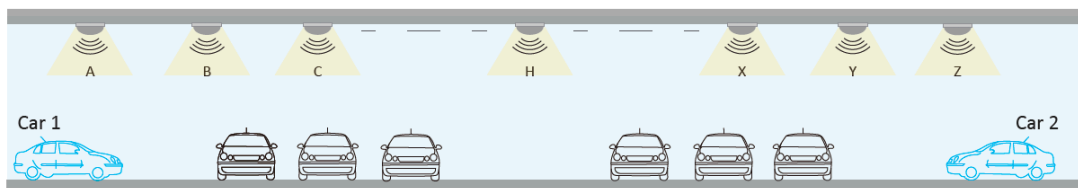

Thanks to the daylight monitoring function, even no movement detected, the sensor will automatically switch on the lamp to pre-defined stand-by dimming level (e.g., 10%), as long as the natural light is below pre-defined lux threshold. (to achieve this unique function stand-by period of the sensor has to be set at $+\infty$).

***Note:**

1. The RF transmission is a triggering signal only to activate the grouped sensors, each sensor will act based on their own settings.
2. Thanks to the Dual-processor technology, the built-in daylight sensor will shut off the lamp in real time regardless of any movements as long as the detected natural light is higher than pre-defined lux threshold.



LIGHT EFFICIENT DESIGN HEADQUARTERS 188 S. Northwest Highway • Cary, IL 60013
INNOVATION & MANUFACTURING CENTER 30 Log Bridge Road, Building 200 • Middleton, MA 01949
847.380.3540 • led-llc.com

08.04.20 Information is subject to change without notice.