

PROJECT: _____
 CATALOG #: _____
 FIXTURE TYPE: _____
 NOTES: _____

TL Luxe Troffer Gen 1 Design Series

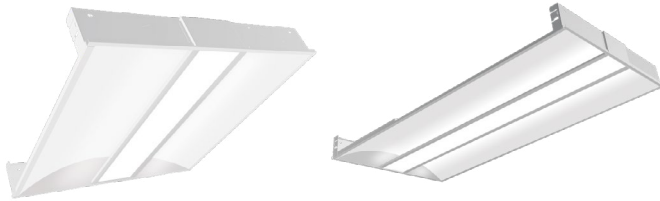

TL 22

TL 24

The newest addition to our Design Series is the **TL Luxe Troffer Gen 1** with its innovative approach to the traditional “center basket” design. Fully customizable with options for 3000K, 3500K, and 4000K CCT and offered in two sizes, 2 ft by 2 ft and 2 ft by 4 ft. This environment enhancing luminaire has a unique direct/indirect light distribution that spreads across the bottom and illuminates the curved reflector for optimized ambient lighting as well directs the light below to any work surface. Control options can be added for greater savings and increased efficiency.

APPLICATIONS

Commercial, Educational, Medical and Retail applications, etc.

REPLACEMENT

3 Lamp T8 17W, 3 Lamp T5 14W,
 4 Lamp T8 32W, 3 Lamp T5 28W

OPTIONS & ACCESSORIES



EL



Flange Kit



Surface Mount Kit



PERFORMANCE INFORMATION

SIZE	SERIES NUMBER	WATT	LUMENS	CCT
2' x 2'	TL 22 40 G1 40K L	30W	3,000	4000K*
2' x 2'	TL 22 40 G1 40K M	35W	3,500	4000K*
2' x 2'	TL 22 40 G1 40K H	40W	3,778	4000K*
2' x 4'	TL 24 50 G1 40K L	30W	3,000	4000K*
2' x 4'	TL 24 50 G1 40K M	40W	4,000	4000K*
2' x 4'	TL 24 50 G1 40K H	50W	4,807	4000K*

*Selectable 3000K, 3500K, and 4000K

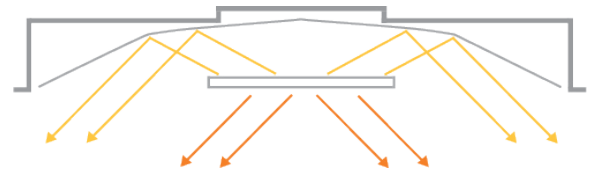

Innovative direct/indirect light distribution

ORDERING GUIDE		EXAMPLE: TL 22 40 G1 35K						
Luminaire Type	Size	Lumen Output*	Generation	Voltage	Selectable CCT	Finish	Selectable Wattage	Options
TL Luxe Troffer	22 2' x 2'	40 3,778 Lumens	G1	BLANK= 120-277V	40K* 4000K	BLANK= White	L= 30W 3,000 Lumens M= 35W 3,500 Lumens H= 40W 3,778 Lumens	BLANK= No Option EL= Emergency Battery
	24 2' x 4'	50 4,807 Lumens					L= 30W 3,000 Lumens M= 40W 4,000 Lumens H= 50W 4,807 Lumens	

*Selectable 3000K, 3500K, and 4000K

Due to continuous product improvements, specification and/or equipment updates may change without notice.

SPECIFICATIONS

HOUSING

Rugged, one-piece cold-rolled steel coated polyester, painted after fabrication.

AMBIENT TEMPERATURE

Suitable for use in 0°C to 40°C (32°F to 104°F)

MOUNTING

Recessed mounting. Optional Flange and Surface Kits available.

EFFICACY

Up to 100 lumens per watt (see individual wattage data)

CCT AND CRI

Selectable 3000K, 3500K and 4000K CCT available; 80+CRI

OPTICS

High transmitting acrylic PMMA lens for superior shielding and wide distribution.

WARRANTY

5-year limited warranty. Comprehensive warranty terms can be located on www.slgus.com.

ELECTRICAL

High quality constant current drivers rated for 50/60Hz. Operation 120-277V input. Standard 0-10V dimming.

ENERGY DATA

Power factor above 90%.

FINISH

Standard Polyester Powder White finish. Multi-stage process for 3 mil thickness offers superior corrosion resistance and maximum durability.

CERTIFICATIONS

UL Listed for damp and dry locations. FCC compliant. RoHS compliant. Design Lights Consortium® (DLC) 4.4 Standard qualified product. Not all versions of this product may be DLC qualified. Please visit www.slgus.com to confirm which versions are qualified.

DIMENSIONS

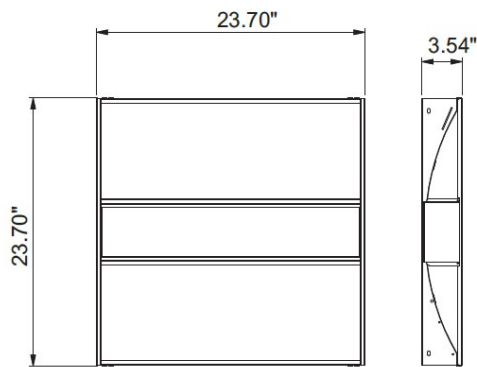

TL 22

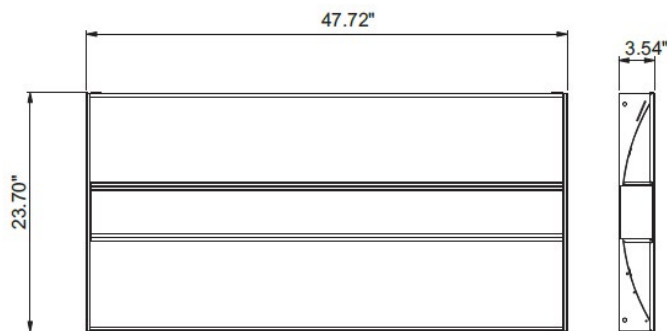

TL 24

Due to continuous product improvements, specification and/or equipment updates may change without notice.

PHOTOMETRIC DATA

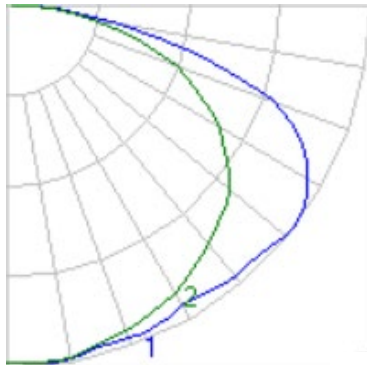

TL 22 40 G1 40K H

Lumens: 3,778 Lumens
 Power: 40W
 Efficacy: 95 lm/W

CANDLEPOWER DISTRIBUTION			
Vertical °	Horizontal °		
	0 °	45 °	90 °
45 °	785	831	902
65 °	514	601	727
75 °	306	365	418
85 °	96	97	101

ZONAL LUMEN SUMMARY		
Zone	Lumens	%Fixt
0-30	777.97	20.60
0-40	1330.1	35.20
0-60	2663.48	70.50
0-90	3777.74	100.00

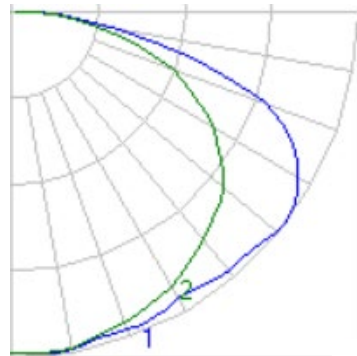

TL 24 50 G1 40K H

Lumens: 4,807 Lumens
 Power: 40W
 Efficacy: 96 lm/W

CANDLEPOWER DISTRIBUTION			
Vertical °	Horizontal °		
	0 °	45 °	90 °
45 °	970	1046	1140
65 °	684	829	1047
75 °	430	537	647
85 °	138	134	155

ZONAL LUMEN SUMMARY		
Zone	Lumens	%Fixt
0-30	944.47	19.60
0-40	1619.26	33.70
0-60	3305.67	68.80
0-90	4807.29	100.00

Due to continuous product improvements, specification and/or equipment updates may change without notice.

APPLICATION GUIDE



2' X 2'		
Light Level	Lumen Output	Wattage
1	3000	30
2	3500	35
3	4000	40

2' X 4'		
Light Level	Lumen Output	Wattage
1	3000	30
2	4000	40
3	5000	50

8' X 10' SPACING			
Uniformity			
Light Level (fc)	Max/Min	Avg/Min	LPD (w/ft ²)
32	1.6:1	1.3:1	0.37
37			0.44
46			0.5

10' X 12' SPACING			
Uniformity			
Light Level (fc)	Max/Min	Avg/Min	LPD (w/ft ²)
28	1.7:1	1.4:1	0.25
37			0.33
46			0.42

ACCESSORIES

	Product Image	Size
Surface Kit		2' x 2'
		2' x 4'
Flange Kit		2' x 2'
		2' x 4'

Due to continuous product improvements, specification and/or equipment updates may change without notice.

LUMEN AMBIENT TEMPERATURE (LAT) MULTIPLIERS

Ambient Temperature		Lumen Multiplier
0°C	32°F	1.04
5°C	41°F	1.04
10°C	50°F	1.03
15°C	59°F	1.02
20°C	68°F	1.01
25°C	77°F	1.00
30°C	86°F	0.99
35°C	95°F	0.98
40°C	104°F	0.97

PROJECTED LED LUMEN MAINTENANCE

Operating Hours	0	25,000	50,000	100,000
Lumen Maintenance Factor	1.00	0.97	0.97	0.96

ELECTRICAL DATA

Watt	Current (A)			
	120V	208V	240V	277V
30W	0.25	0.14	0.13	0.11
35W	0.29	0.17	0.15	0.13
40W	0.33	0.19	0.17	0.14
50W	0.42	0.24	0.21	0.18

Due to continuous product improvements, specification and/or equipment updates may change without notice.