

LEDVANCE Luminaires

SLIM CCT SELECTABLE MICRODISK

PERFORMANCE CLASS™

Application

The LEDVANCE Performance Class Slim CCT Selectable Microdisk is a slim profile LED downlight kit with remote driver that at either 120VAC or 120-277VAC. The 1/2" height allows for installation directly under joists in new and remodel construction.

Benefits and Features

- High CRI (>90) ensures a high quality light
- 1/2" height facilitates installations in most residential applications
- IC Rated for contact with ceiling insulation
- All necessary quick connectors are included with each SKU
- Up to 87 LPW
- 2700K, 3000K, 3500K, 4000K, 5000K color temperature selectable via the switch located on the driver
- Offered in 6.5, 10, 14, 19, and 23 watt versions
- Energy savings up to 92%

Electrical

- Offered in 120V or 120-277V (see ordering guide for further details)
- Power Factor >0.9
- THD <20%
- Offered in Phase-Cut dimming and 0-10V dimming models (see ordering guide for further details)

Rated Life

- 50,000 hours (L₉₀)

Warranty

- 5-year
- NLB Trusted Warranty Program

Ambient Operating Range

- -4°F to +104°F (-20°C to +40°C)

Installation

- For installation into 3", 4", 6", 8" and 12" ceiling cut-outs.
- Universal Metal Frame sold separately as accessory for new construction: fits all sizes in Slim MICRODISK portfolio.
- Quick connectors are included in the box with purchase of each SKU



Wattage Comparison

Traditional Source	LED System Wattage	Energy Savings
100W BR40	6.5W	85%
120W Incandescent	10W	88%
23W CFL	14W	30%
32W CFL	19W	63%
40W CFL	23W	48%

Certifications and Listings

- cETLus
- RoHS
- FCC
- Title 24 Compliant
- TAA
- ENERGY STAR®
- Suitable for wet locations
- FT6 listed cable
- Suitable for use in closets, compliant with NFPA 70, NEC section 410.16 (A)(3) and 410.16 (C)(5)



Catalog #	Type
Project	
Comments	
Prepared by	

Ordering Guide

LEDMD	XR	3A	/	XXXX	XXX	X	9	SC3	/	XX
Product Name	Dimensions	Generation		Lumens	Voltage	Dimming	CRI	CCT		Color/Finish
LEDMD = LED Slim	3R = 3" Round	3A = Generation 3A		500 = 500 Lumens	S = 120V	T = Triac Dimming	9 = >90	SC3 = 2700/3000/3500/4000/5000K		WH = White Finish
MICRODISK	4R = 4" Round			800 = 800 Lumens	UNV = 120-277V	D = 0-10V Dimming				BL = Black Finish
	6R = 6" Round			1200 = 1200 Lumens						
	8R = 8" Round			1600 = 1600 Lumens						
	12R = 12" Round			2000 = 2000 Lumens						

Ordering Information

Item Number	Ordering Abbreviation	Power (W)	Total Fixture Lumens		Input Voltage	Dimming	CRI	Color Temp (CCT)	IC Rated	MTO*
			(lm)	LPW						
63053	LEDMD3R3A/500ST9SC3/WH	6.5	500	77	120V	Phase-cut	>90	2700/3000/3500/4000/5000K	Yes	-
63059	LEDMD4R3A/800ST9SC3/BL	10	800	80	120V	Phase-cut	>90	2700/3000/3500/4000/5000K	Yes	-
63054	LEDMD4R3A/800ST9SC3/WH	10	800	80	120V	Phase-cut	>90	2700/3000/3500/4000/5000K	Yes	-
63055	LEDMD6R3A/800ST9SC3/WH	10	800	80	120V	Phase-cut	>90	2700/3000/3500/4000/5000K	Yes	-
63060	LEDMD6R3A/800ST9SC3/BL	10	800	80	120V	Phase-cut	>90	2700/3000/3500/4000/5000K	Yes	-
63056	LEDMD6R3A/1200ST9SC3/WH	14	1200	86	120V	Phase-cut	>90	2700/3000/3500/4000/5000K	Yes	-
63057	LEDMD8R3A/1600ST9SC3/WH	19	1600	84	120V	Phase-cut	>90	2700/3000/3500/4000/5000K	Yes	-
63058	LEDMD12R3A/2000ST9SC3/WH	23	2000	87	120V	Phase-cut	>90	2700/3000/3500/4000/5000K	Yes	-
63598	LEDMD4R3A800UNVD9SC3/WH	10	800	80	120-277V	0-10V	>90	2700/3000/3500/4000/5000K	Yes	MTO
63599	LEDMD6R3A800UNVD9SC3/WH	14	800	80	120-277V	0-10V	>90	2700/3000/3500/4000/5000K	Yes	MTO
63600	LEDMD6R3A1200UNVD9SC3/WH	14	1200	86	120-277V	0-10V	>90	2700/3000/3500/4000/5000K	Yes	MTO
63601	LEDMD8R3A1600UNVD9SC3/WH	19	1600	84	120-277V	0-10V	>90	2700/3000/3500/4000/5000K	Yes	MTO
63603	LEDMD4R3A800UNVD9SC3/BL	10	800	80	120-277V	0-10V	>90	2700/3000/3500/4000/5000K	Yes	MTO
63604	LEDMD6R3A800UNVD9SC3/BL	10	800	80	120-277V	0-10V	>90	2700/3000/3500/4000/5000K	Yes	MTO

*Made to Order

Compatible Phase-Cut Dimmers

Make	Leading or Trailing Edge	Model
Leviton SureSlide	L	6674
Lutron Maestro C-L	L	MACL-153M
Lutron Diva	L	DVCL-153P
Lutron Caseta	L	PD-6WCL
Legrand Radiant	L	RHCL453P
Lutron Diva	T	DVELV-300P
Lutron Maestro	T	MAELV-600

Compatible 0-10V Dimmers

Make	Type	Model
Leviton	0-10V	DS710
Leviton	0-10V	IP710
Lutron	0-10V	NTSTV-DV
Lutron	0-10V	DVSTV
Lutron	0-10V	DVTV-WH
Legrand	0-10V	H4FBL3PW

Photometric Information

6.5W 3"

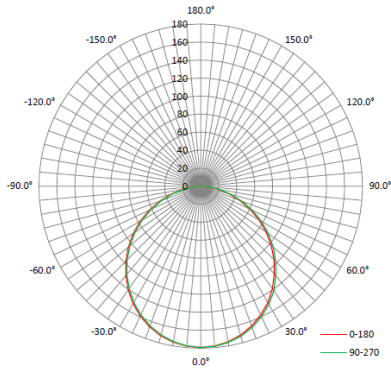

10W 4"

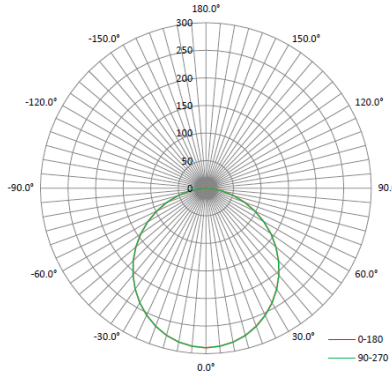

10W 6"

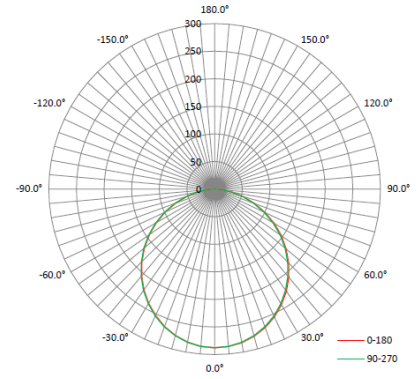

14W 6"

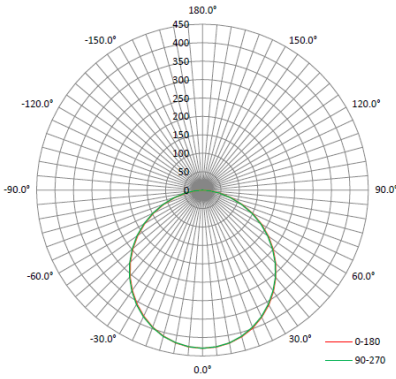

19W 8"

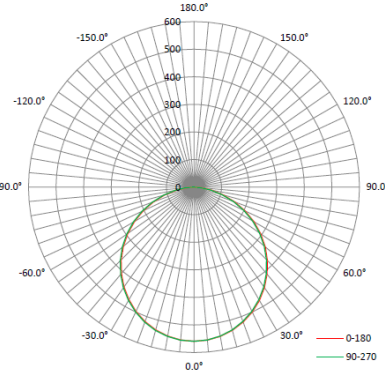

23W 12"

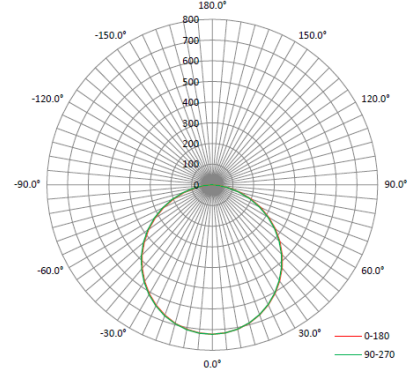

Physical Information

Lamp Description	Diameter (in)	Height (in)
3R = 3" round	4.33	0.69
4R = 4" round	5.28	0.69
6R = 6" round	7.32	0.69
8R = 8" round	9.49	0.69
12R = 12" round	13.5	0.69

3 inch

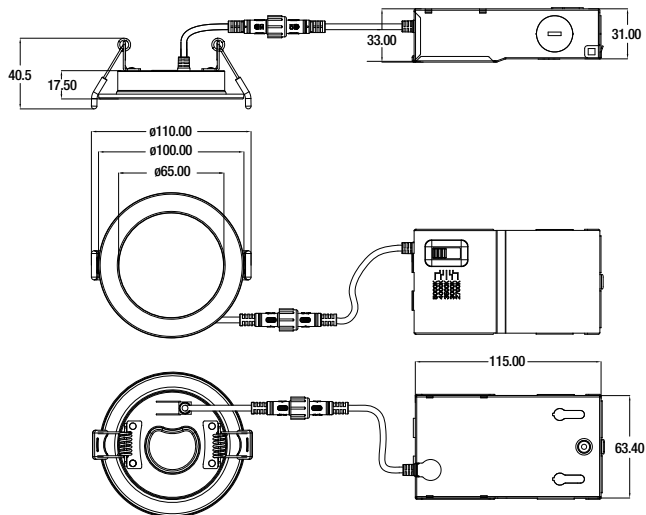

4 inch

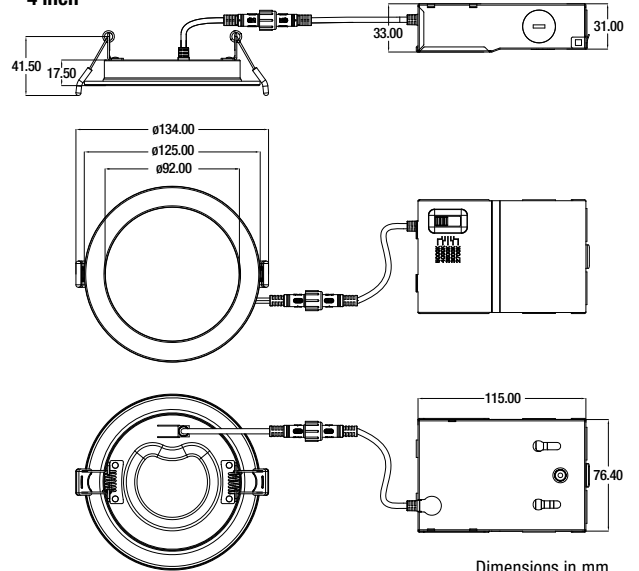

Dimensions in mm

Physical Information (continued)

6 inch

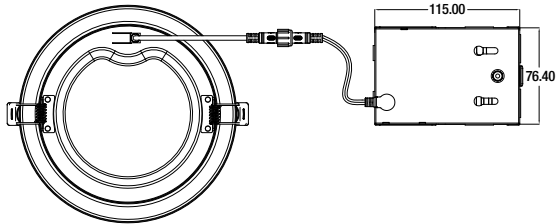
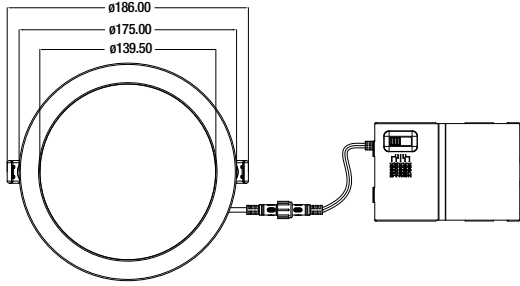
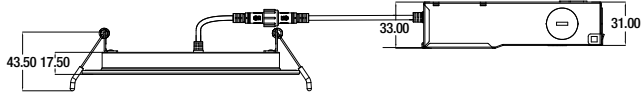

8 inch

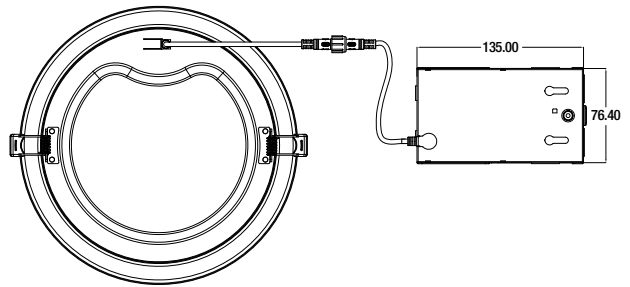
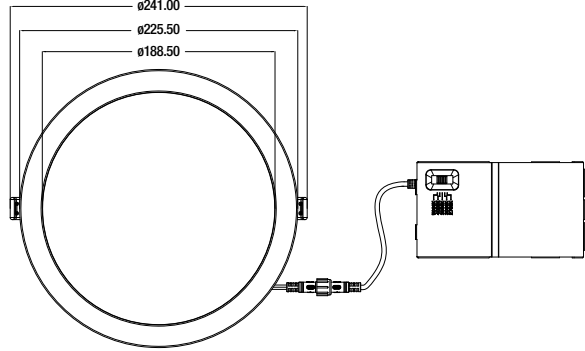
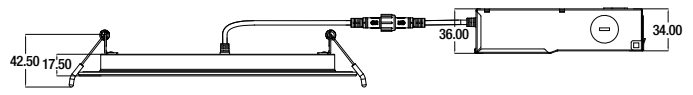

12 inch

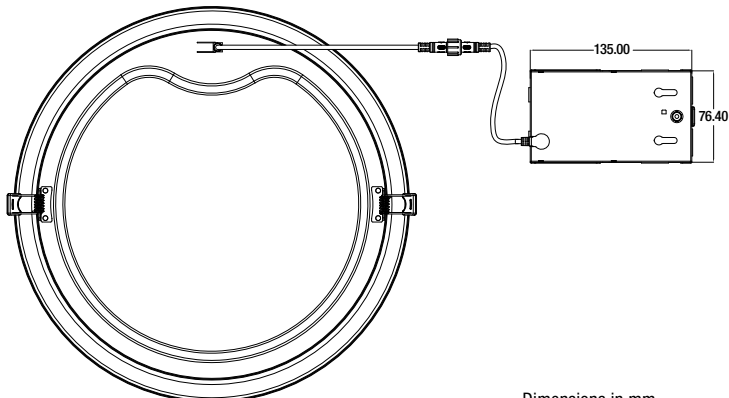
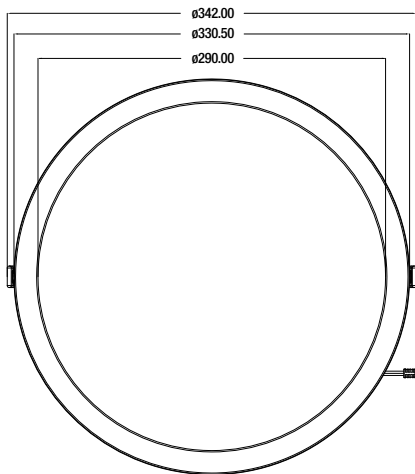
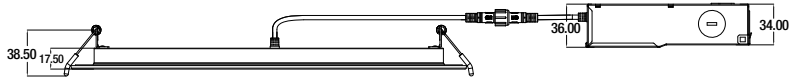

Dimensions in mm

Accessories

Item Number	Ordering Abbreviation	Item Description
63202	SLIMMD3A3/TRIMBLK	Black trim for 3" models
63203	SLIMMD3A3/TRIMBZ	Bronze trim for 3" models
63204	SLIMMD3A3/TRIMSN	Satin nickel trim for 3" models
63205	SLIMMD3A4/TRIMBLK	Black trim for 4" models
63206	SLIMMD3A4/TRIMBZ	Bronze trim for 4" models
63207	SLIMMD3A4/TRIMSN	Satin nickel trim for 4" models
63208	SLIMMD3A6/TRIMBLK	Black trim for 6" models
63209	SLIMMD3A6/TRIMBZ	Bronze trim for 6" models
63210	SLIMMD3A6/TRIMSN	Satin nickel trim for 6" models
63211	SLIMMD3A8/TRIMBLK	Black trim for 8" models
63212	SLIMMD3A8/TRIMBZ	Bronze trim for 8" models
63213	SLIMMD3A8/TRIMSN	Satin nickel trim for 8" models
63214	SLIMMD3A12/TRIMBLK	Black trim for 12" models
63215	SLIMMD3A12/TRIMBZ	Bronze trim for 12" models
63216	SLIMMD3A12/TRIMSN	Satin nickel trim for 12" models

Item Number	Ordering Abbreviation	Length	Width
60793	LEDMD6FTEXCBL	6ft	-
60794	LEDMD10FTEXCBL	10ft	-
60795	LEDMD20FTEXCBL	20ft	-
62959	LEDSLIMMDFRAME	20.72in (526mm)	9.65in (2450mm)

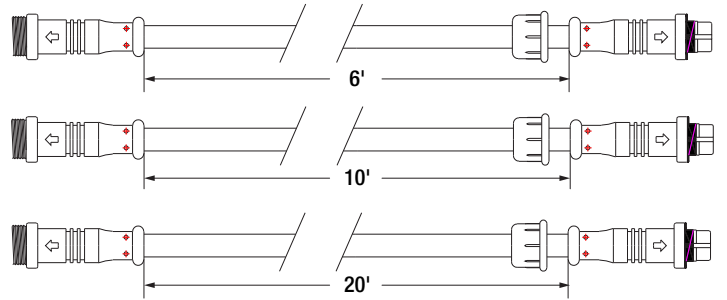

Metal Frame

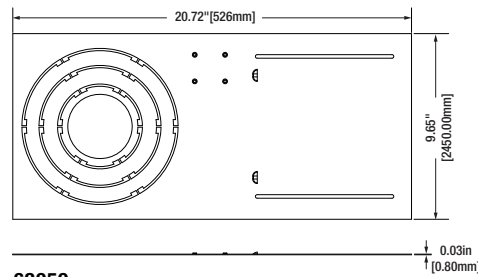
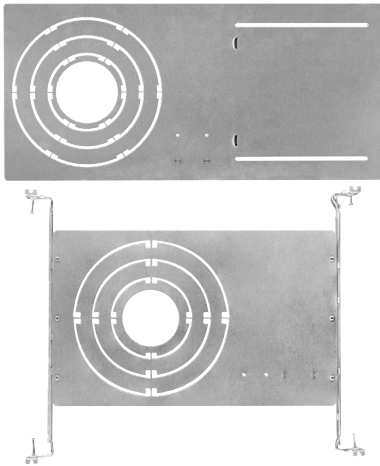

62959

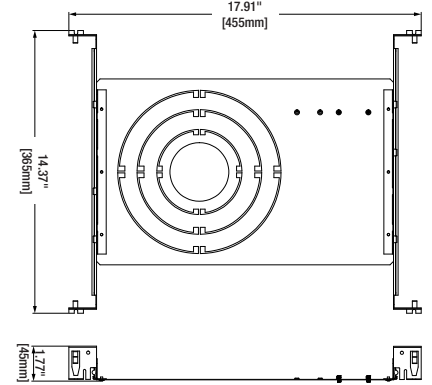

63743

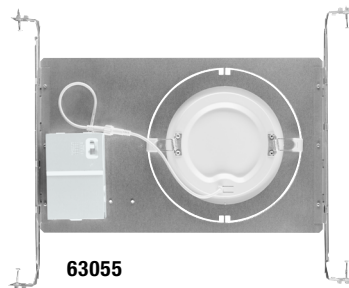

63055

Hole Cut Templates

MD3 Hole Cut Template

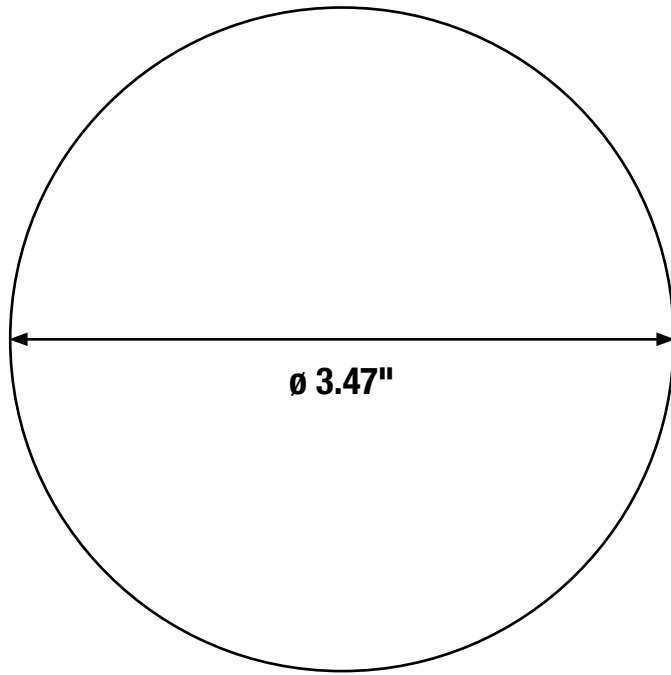

MD4 Hole Cut Template

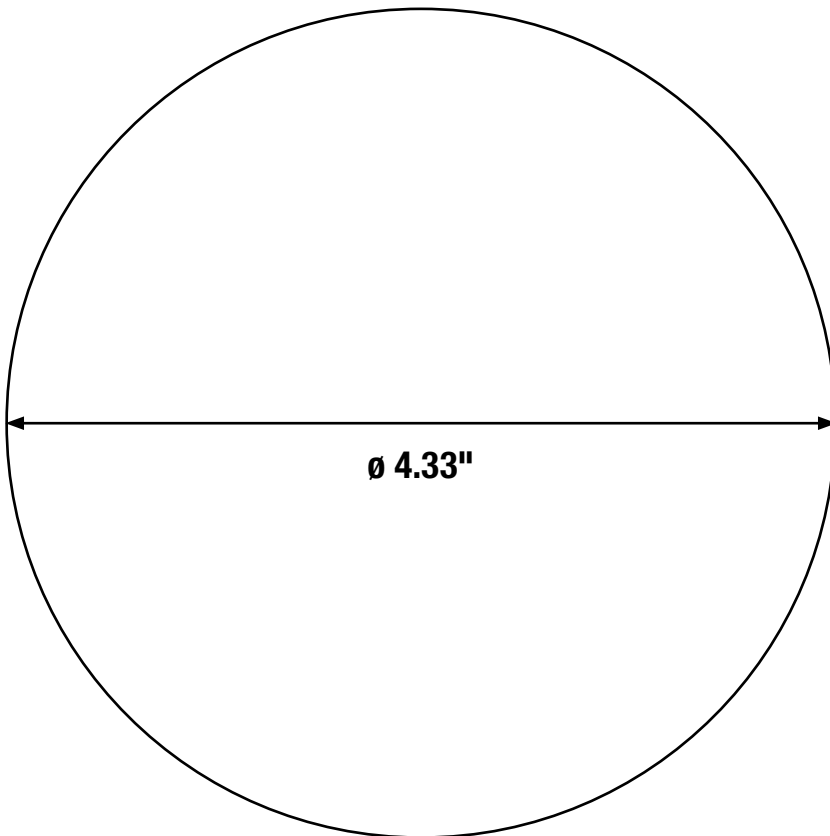

Hole Cut Templates

MD6 Hole Cut Template

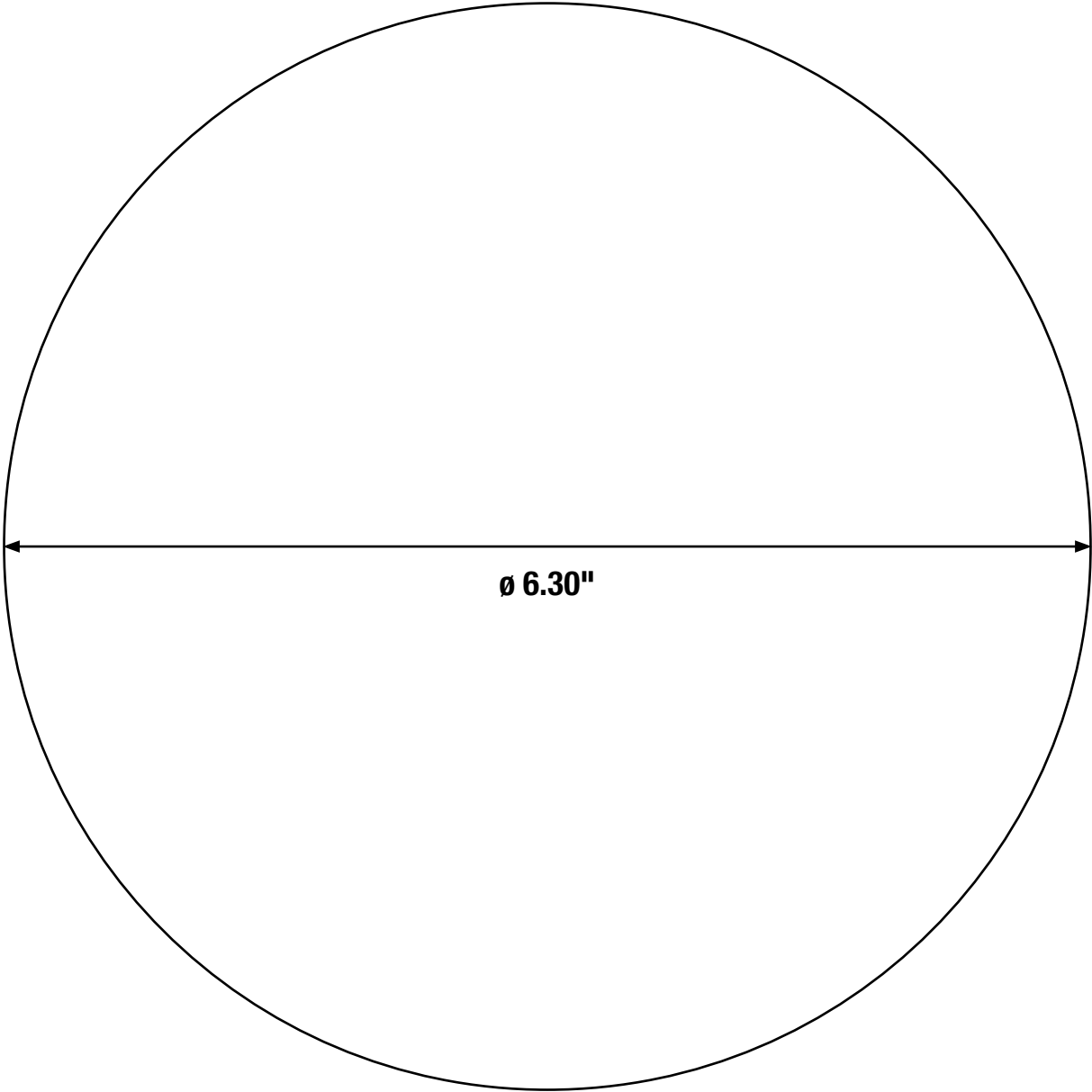

Hole Cut Templates

RT8 Hole Cut Template

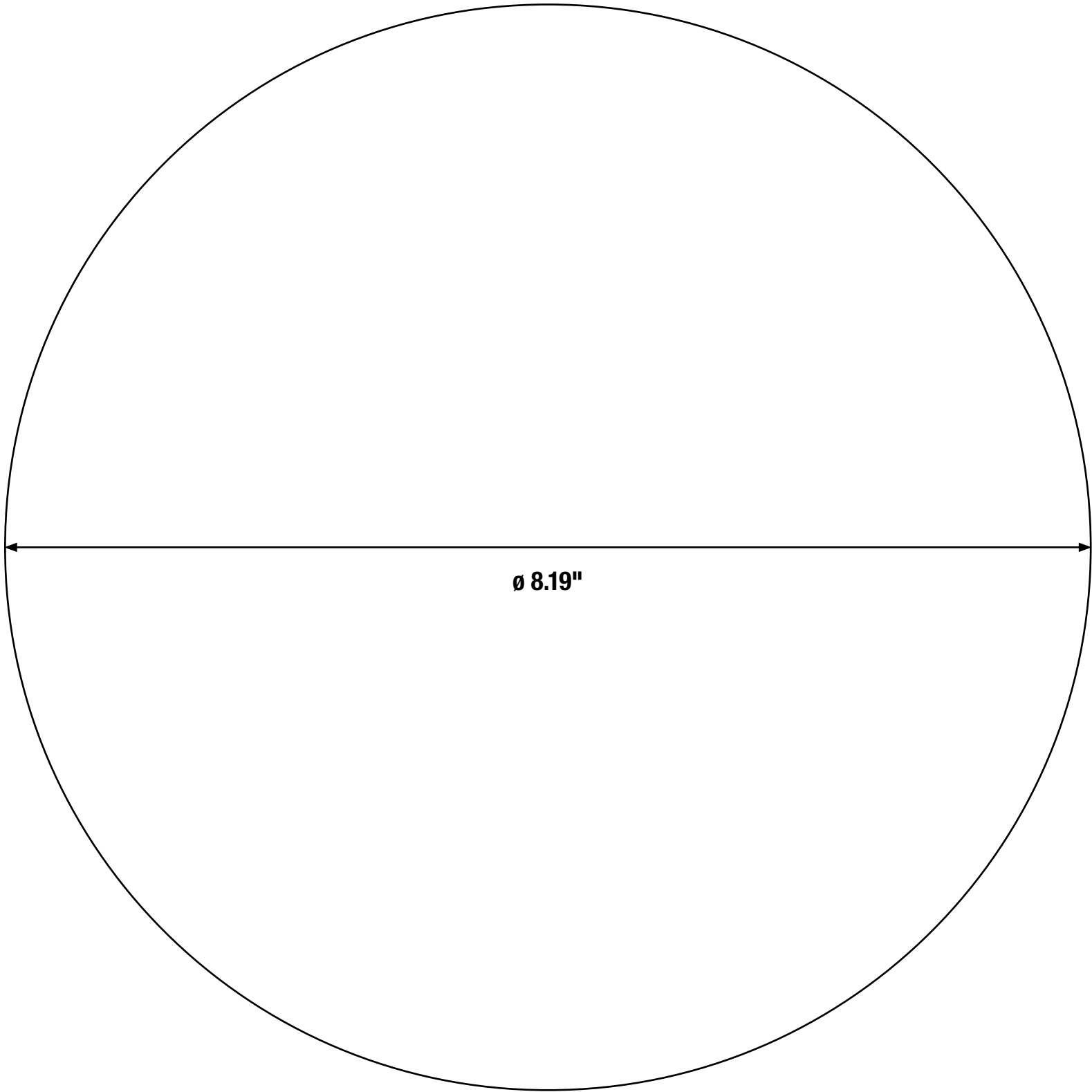

LEDVANCE LLC
181 Ballardvale Street, Suite 203
Wilmington, MA 01887 USA
Phone 1-800-LIGHTBULB (1-800-544-4828)
www.ledvanceUS.com

LEDVANCE is a registered trademark.
All other trademarks are those of their respective owners.
Specifications subject to change without notice.



SCAN TO FOLLOW US
ON SOCIAL MEDIA

