



STEALTH Sensor with 110° view. Double Look Down lens, surge protection, LED detection indicator and Color Matched Lens.

Color: White

Weight: 0.9 lbs

Project:

Type:

Prepared By:

Date:

Technical Specifications

Compliance

UL Listed:

Raintight Photoelectric Switch

Electrical

Switching Capacity:

8 amps

Voltage:

120V
300W LED

Surge Protection:

I.E.C specs

Sensor Settings

Detection Pattern:

50' x 100°

Time Adjustment:

5 seconds to 12 minutes

Power Consumption:

1 watt

Other

Warranty:

10-year sensor warranty

Dimensions

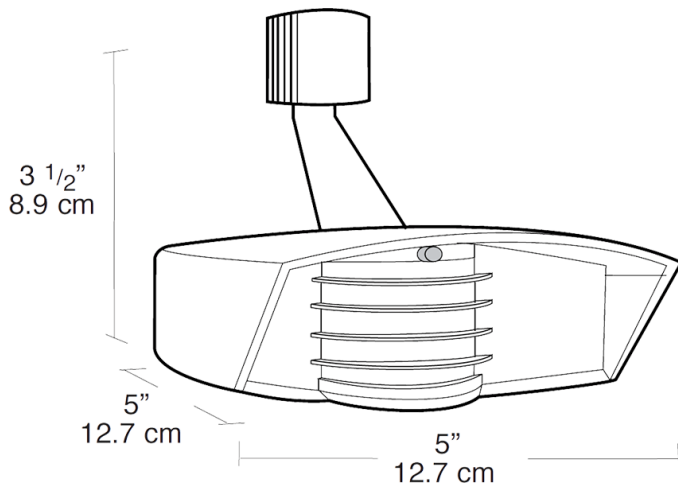

Features

- Compatible with LED lamps
- Temperature compensation
- Radio frequency immunity
- 6000 volt surge protection
- LED detection & "on guard" indicator
- Color matched vandal resistant lens and grill
- Protected manual override with auto reset
- Can be wired in parallel