

Color: Brushed nickel

Weight: 0.0 lbs

Project:

Type:

Prepared By:

Date:

Technical Specifications

Performance

Product Type:

Wafer Trim

Description:

Mounting plates, extension cables, color trims and goof rings for canless downlights.

Installation

Mounting:

Snap on

Construction

Size:

3"

Shape:

Round

Finish:

Brushed Nickel

Housing Material:

Metal

Trim Style:

Smooth

Compliance

Listings:

None

Environment:

Suitable for use in dry and damp environments for indoor and outdoor applications.
Not suitable for applications with direct sunlight.

California Title 20 Compliant:

No

California Title 24 JA8 Compliant:

No

California Energy Commission (CEC) Status:

Lawful for Sales in California

Other

Compatible Products:

See Downlight Accessory Compatibility List for a complete listing of compatible products.

Dimensions

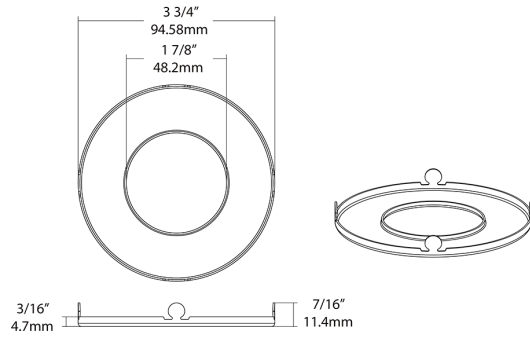

Features

Trims for Edge-Lit Wafer