

LEDVANCE LUMINAIRES DUAL SELECTABLE FLAT PANEL RETROFIT KIT



LEDVANCE LUMINAIRE SPECIFICATION DATA

Catalog #	Comments
Project	
Type	
Prepared by	

PERFORMANCE CLASS™

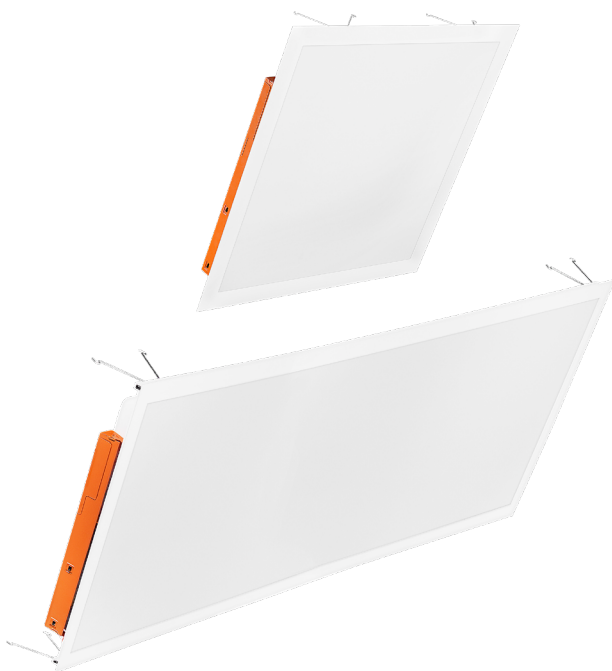

APPLICATION

The LEDVANCE EZ SWAP™ is offered in two sizes — 2' x 2' and 2' x 4', and is ideal for retrofit projects illuminating offices, retail spaces, hallways, multipurpose rooms and hospitality areas.

BENEFITS & FEATURES

- Dual selectability increases the lighting options available with each SKU and facilitates inventory management
- Torsion springs slide in channels for easy and flexible installation into existing traditional fixtures
- DLC5.1 listing ensures that this product is eligible for most rebates
- All mounting accessories are included with the luminaire
- Up to 110 LPW
- Selectable color temperature: 3500/4000/5000K
- CRI > 80
- Offered in 20, 30, or 35 watts (2 x 2) and 30, 35, or 45 watts (2 x 4)
- Factory installed emergency battery back-up models are available
- Energy savings up to 64%



ELECTRICAL

- 120-347VAC
- Power Factor > .9
- THD < 20%
- 0-10V dimmable

OPERATING TEMPERATURE

- -4°F to 122°F (-20°C to 50°C)

RATED LIFE

- 50,000 hours (L₇₀)

CERTIFICATIONS & LISTINGS

- cETLus
- DLC 5.1 Standard
- Damp rated
- FCC
- RoHS

WARRANTY

- 5 year
- NLB Trusted Warranty Program

INSTALLATION

- This luminaire is designed to retrofit existing troffers

TRADITIONAL FLUORESCENT TROFFER COMPATIBILITY*

SIZE	MANUFACTURER	MODEL #
2 × 2	Lithonia	987218
	Lithonia	2GT8 3 17 A12 MVOLT 1/3 GEUS
	Simkar	55-22234
	Hubbell	ST822-232U6G-FSA12125-EU
	Cooper	ATW-SW4-2GR8-2U6T8A-UNV-EB81-U
2 × 4	Cooper	APT-432-L741
	Cooper	2GR8-332A-UNV-E
	Metalux	METALUX-GR-153
	Simkar	673005
	Cooper	APP-332-2EB

*Representative list of traditional fluorescent troffers tested. Different model types may be compatible with EZ Swap Panels. List is not exclusive.

Please note, replacing an air handling fixture with these luminaires will void the air handling capabilities of the luminaire.

DIMMER COMPATIBILITY

MAKE	DIMMER TYPE	MODEL
Leviton	0-10V	DS710
Leviton	0-10V	IP710
Lutron	0-10V	NTSTV-DV
Lutron	0-10V	DVSTV
Lutron	0-10V	DVTV-WH
Legrand	0-10V	RH4FBL3PW

WATTAGE COMPARISON

PANEL SIZE	TRADITIONAL SOURCE	TRADITIONAL SYSTEM WATTAGE	LED SYSTEM WATTAGE	ENERGY SAVINGS
1 × 4	2-lamp 28T8	49	30	39%
	2-lamp 32T8	56	30	46%
2 × 2	3-lamp 17T8	48	30	38%
	2-Ulamp 31T8	56	30	46%
2 × 4	2-lamp 28T8	49	30	39%
	2-lamp 32T8	56	30	46%
	3-lamp 32T8	75	30	60%
	3-lamp 28T8	64	35	45%
	3-lamp 32T8	75	35	53%
	3-lamp 28T8	64	40	38%
	3-lamp 32T8	75	40	47%
	4-lamp 28T8	97	40	59%
4-lamp 32T8	112	40	64%	

ORDERING GUIDE

PANELDORKIT	2A	XX	UNH	D	8	SC7	XX	WH	-
PRODUCT NAME	GENERATION	WATTAGE	VOLTAGE	DIMMING	CRI	COLOR TEMP	DIMENSIONS	COLOR/FINISH	OPTIONS
PANELDORKIT = Panel Retrofit Kit	Generation = 2A	35 = 20, 30, or 35W selectable 45 = 30, 35, or 45W selectable	UNH = 120-347V	D = 0-10V dimmable	8 = >80 CRI	SC7 = 3500, 4000, or 5000K	22 = 2'x2' 24 = 2'x4'	WH = White Finish	blank = no option E = Emergency Battery Back-up

ORDERING INFORMATION

ITEM #	ORDERING ABBREVIATION	WATTAGE (W)	INPUT VOLTAGE (V)	DIM.	CRI	COLOR TEMP (CCT)	DISTRIBUTION	TOTAL LUMENS (LM)	DLC	LPW	OPTIONS	MTO*
65851	PANELDORKIT2A35UNHD8SC722WH	20/30/35	120-347	0-10V	>80	3500K/4000K/5000K	120°	2200/3300/3850	5.1 Std	up to 110	-	-
65852	PANELDORKIT2A45UNHD8SC724WH	30/35/45	120-347	0-10V	>80	3500K/4000K/5000K	120°	3300/3850/4950	5.1 Std	up to 110	-	-
64113	PANELDKIT2A35UNHD8SC722WHE	20/30/35	120-347	0-10V	>80	3500K/4000K/5000K	120°	2200/3300/3850	5.1 Std	up to 110	EMBB	√
64114	PANELDKIT2A45UNHD8SC724WHE	30/35/45	120-347	0-10V	>80	3500K/4000K/5000K	120°	3300/3850/4950	5.1 Std	up to 110	EMBB	√

*Made to Order

PHYSICAL INFORMATION

LAMP DESCRIPTION	LENGTH IN (MM)	WIDTH IN (MM)	HEIGHT IN (MM)
2 x 2	22.75 (578)	22.75 (578)	1.37 (35)
2 x 4	22.75 (578)	46.77 (1188)	1.37 (35)

2 x 2

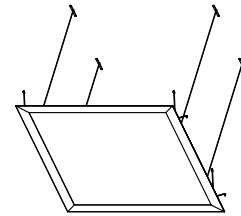
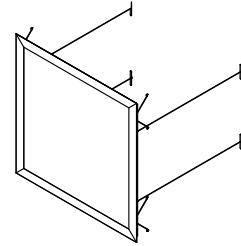
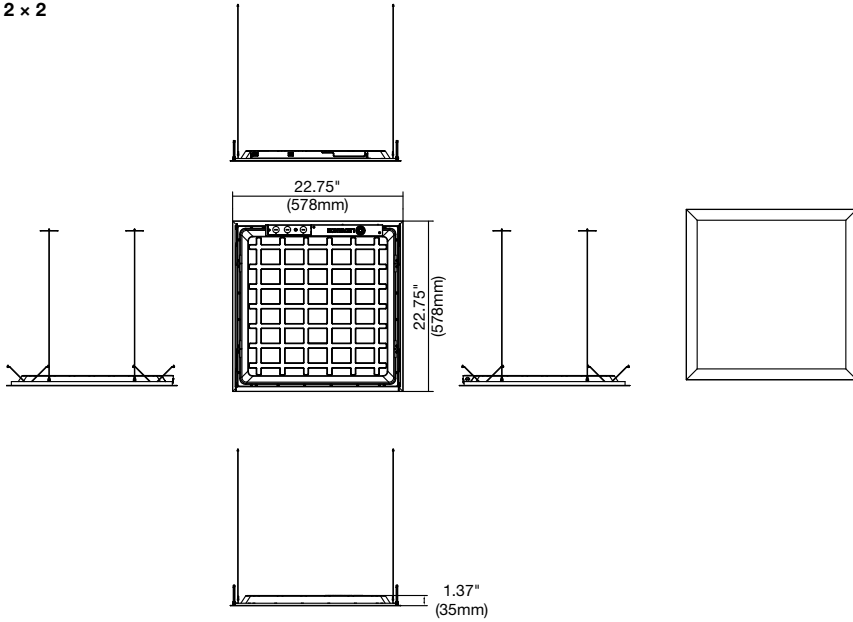

2 x 4

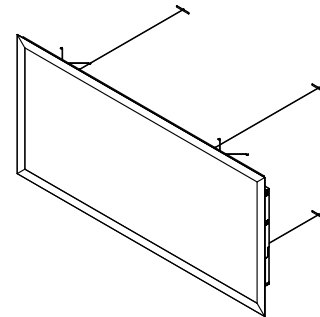
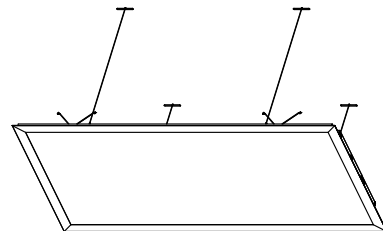
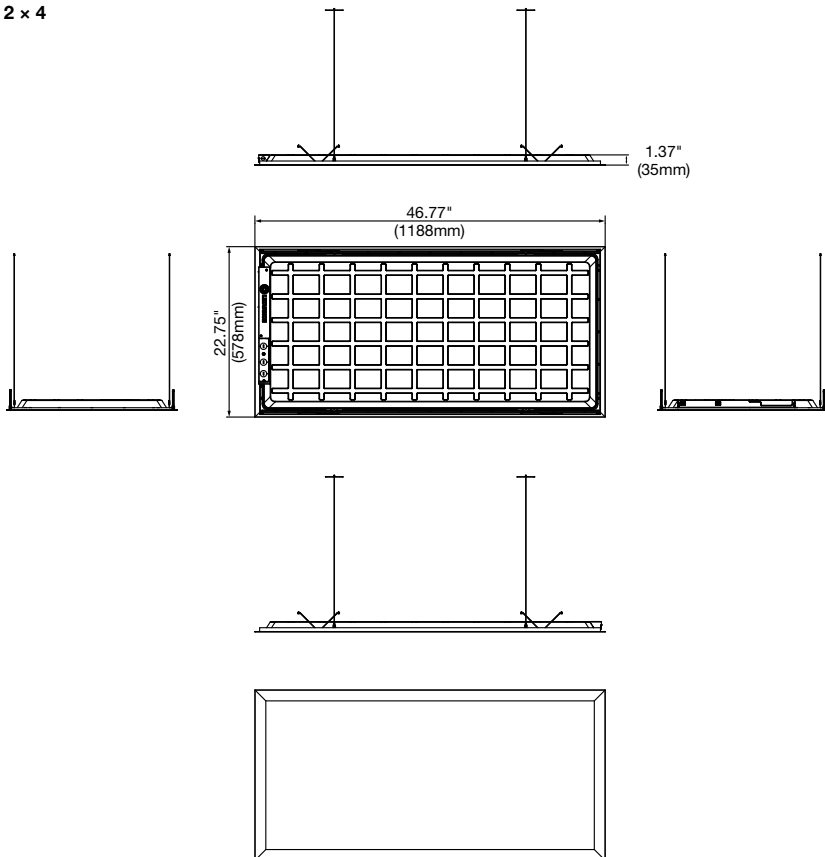

PHOTOMETRIC INFORMATION

LUMINOUS INTENSITY DISTRIBUTION

65851, 20W

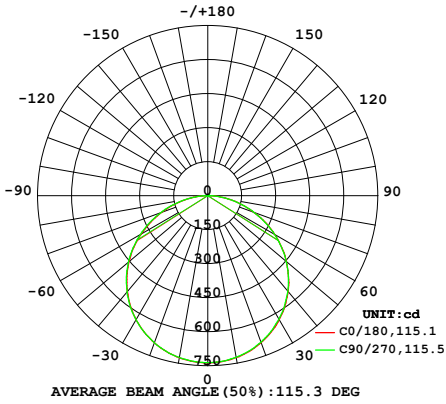

65852, 30W

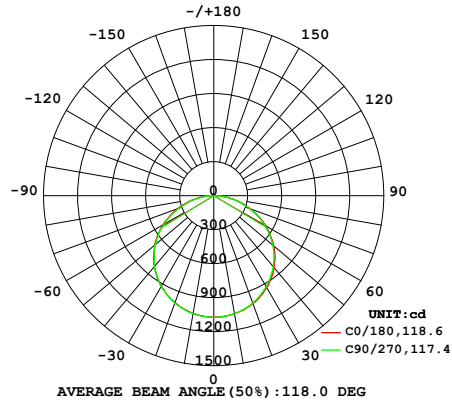

65851, 30W

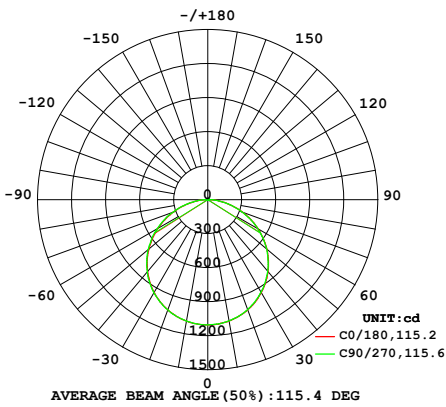

65852, 35W

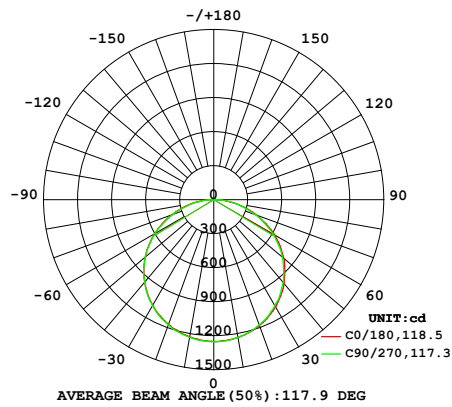

65851, 35W

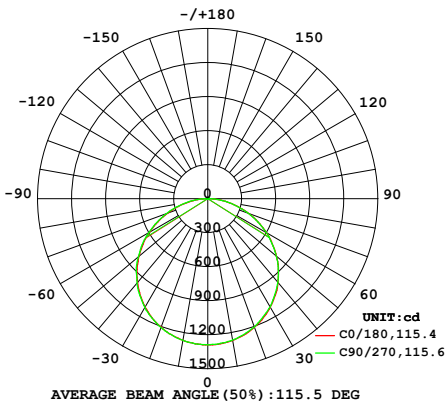

65852, 45W

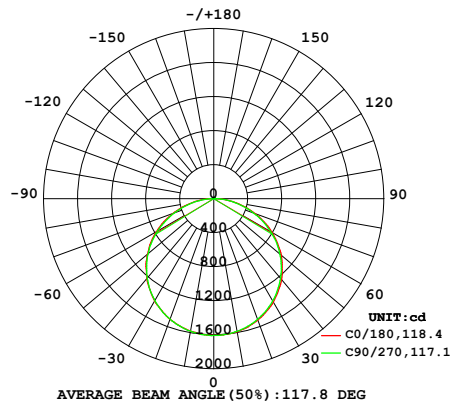



LEDVANCE LLC
181 Ballardvale Street, Suite 203
Wilmington, MA 01887 USA
Phone: 1-800-LIGHTBULB (1-800-544-4828)
www.ledvanceUS.com

LEDVANCE is a registered trademark.
All other trademarks are those of their respective owners.
Specifications subject to change without notice.



SCAN TO FOLLOW US
ON SOCIAL MEDIA